



**SAFETY, PERFORMANCE
AND DEPENDABILITY**

WHEREVER YOU ARE

Antennas and Filters for Railroad & Transportation Communications

Ensuring high availability and reliability for your communication systems

The transportation operators are faced with a growing number of challenges on a daily basis. We understand their reliance on RF networks as a key element to achieve the highest standards of compliance and safety. We offer a complete range of products delivering mobile communications or coverage along highways, railway transportation and commuter services as well as in-building or remote solutions.



COMPROD
Simplifying RF Solutions

COMPROD INC.

High Quality • Superior Performance • Engineering Design • Excellent Technical Support

Trusted by over 1,000 customers worldwide

As the market leader in the designing and manufacturing of RF Antennas, Filtering Systems and In-Building solutions, we at Comprod put innovation and customer satisfaction at the core of our business strategy. Over the past 40 years, we have set ourselves apart by adapting our offering to our client needs, while anticipating future industry trends and opportunities.

The products featured in this catalog are provided specifically for the Railroad industry, and have been installed on the Tier One Railroad RF infrastructure across North America. Our antennas and filters are known for their robust design and long-term reliability. We provide products and services to both transport and commuter railroad clients. Offering full design customization capabilities, we can adapt and optimize any product to meet unique electrical or mechanical performance requirements (e.g. higher front-back ratio; smaller size footprint; black anodization, etc.)

Our Canadian manufacturing facility is certified under ISO 9001:2008 Quality Assurance standards.



Comprod's Headquarter Facilities, Boucherville, QC, Canada

TABLE OF CONTENTS

ANTENNAS	3
Ground Plane Antennas (108-470 MHz)	3
Low Band Exposed Dipole Antennas (30-76 MHz & FM)	5
VHF Exposed Dipole Antennas (118-174 MHz)	7
220MHz Exposed Dipole Antennas (215-225 MHz)	9
Dual Band Exposed Dipoles (160 & 220 MHz)	11
UHF Exposed Dipole Antennas (406-512 MHz)	14
Yagi Antennas (VHF, 220 MHz, UHF, 746-960 MHz, Heavy Duty, Radome)	17
Corner Reflector Antenna (220 MHz)	34
Enclosed Dipole Antennas (746-960 MHz)	36
TRANSIT ANTENNAS	38
VHF/220 MHz Transit Antennas	38
UHF Transit Antennas	39
700-960 MHz Transit Antennas	40
FILTERS	41
2-Inch Cavity Duplexer (132-174 MHz)	41
3-Inch Cavity Duplexer (144-222 MHz)	42
2-Inch Cavity Filter (215-222 MHz)	43
220 MHz Filter (216-222 MHz)	44
4-Inch Cavity Duplexers (138-960 MHz)	45

Ground Plane Antenna Series

The Ground Plane Antenna Series are available in VHF and UHF configurations. These omnidirectional antennas are either wide band unity or 2-3 dB gain antennas. They are constructed from high strength, corrosion resistant aluminum alloy and stainless steel. All our antennas can be completely customized to your particular applications.

- Each antenna has a rugged design to withstand the most extreme environmental conditions.
- Wide frequency band applications.
- The mounting hardware supplied, will permit 0.75" to 2.38" O.D. pipe installation.
- DC ground for lightning protection.
- Ideal for mounting on buildings.

Electrical Specifications	265-70	266-70	267-70	268-70
Frequency Range, MHz	118-174	118-174	118-137	406-470
Nominal Gain, dBd	Unity	2.0-3.0	Unity	2.0-3.0
Bandwidth 1.5:1 VSWR, MHz (% Ctr. Freq.)	6%	1%	15.6% (2:1)	1%
Tuning	Field Adj.	Field Adj.	Fixed	Field Adj.
Polarization	Vertical	Vertical	Vertical	Vertical
Vertical Beamwidth (Ver. Pol.)	80°	40°	71°	38°
Pattern	Omni	Omni	Omni	Omni
Power Rating, Watts	300	250	250	100
Nominal Impedance, Ohms	50	50	50	50
Lightning Protection	DC Ground	DC Ground	DC Ground	DC Ground
Standard Termination	Type N Male	Type N Male	Type N Male	Type N Male
Mechanical Specifications	265-70	266-70	267-70	268-70
Max. Length, in. (mm)	58 (1473)	108 (2743)	67 (1702)	46 (1168)
Width, in. (mm)	55 (1397)	46 (1168)	26.5 (673)	20 (508)
Weight, lbs. (kg)	6.8 (3.3)	6.5 (3.0)	6.0 (2.7)	1.5 (0.7)
Rated Wind Velocity, No Ice, mph (km/h)	150 (241)	125 (201)	125 (201)	125 (201)
Rated Wind Velocity, 0.5" (13mm) Ice, mph	140(225)	85 (137)	110 (177)	85 (137)
Lateral Thrust @ 100 mph wind, lbs. (kg)	31.8	40 (18.1)	24 (10.7)	7.3 (3.3)
Bending Moment @top clamp: 100 mph, ft.*lb	41 (5.7)	94 (13)	28 (3.9)	12 (1.6)
Projected Area, ft ² (m ²)	1.2	1.57	0.88 (0.082)	0.27
Mounting Hardware Included	167-85 Clamp	167-85 Clamp	167-85 Clamp	167-85 Clamp

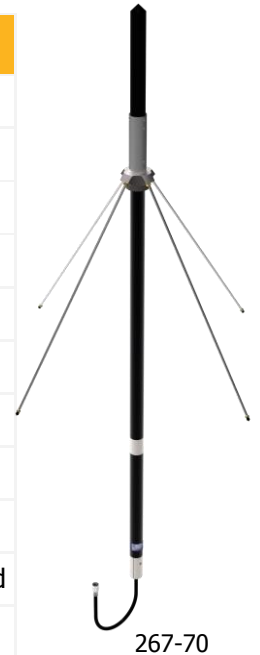

267-70

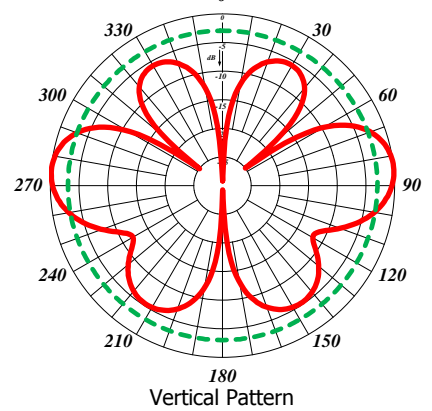
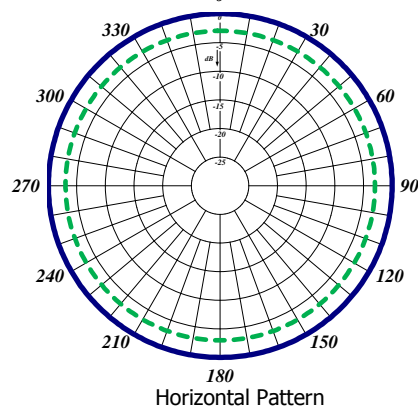
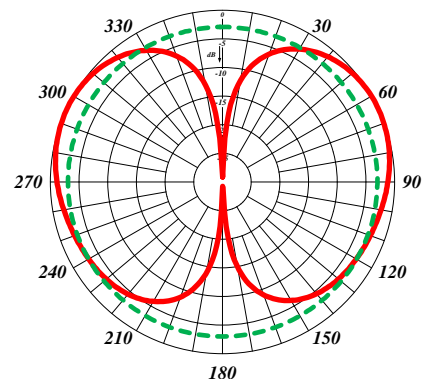
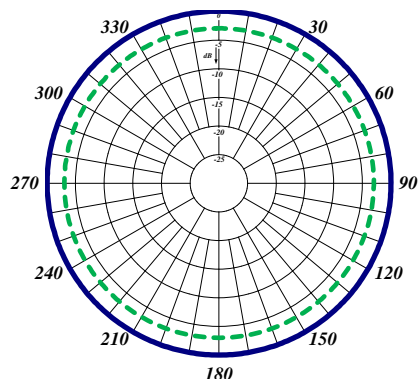
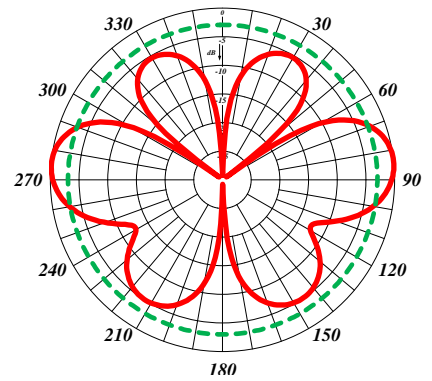
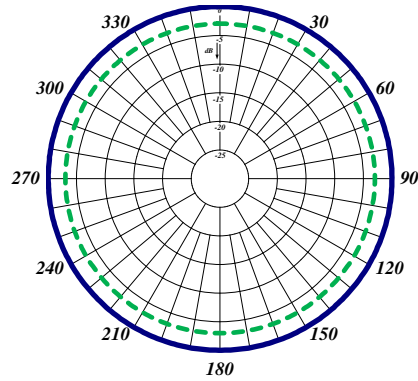
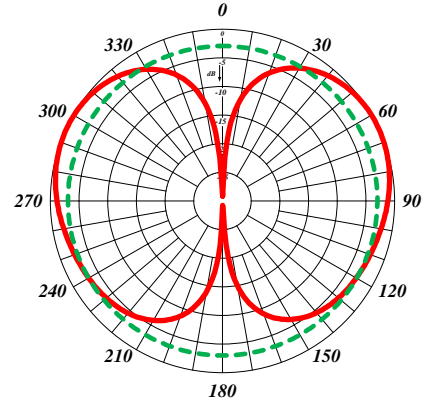
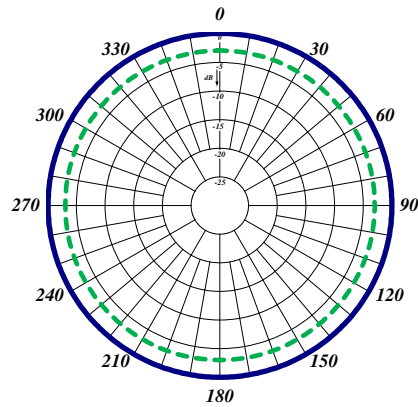

530 Series Low Band Exposed Dipole Antenna

The Low Band Exposed Dipole Antenna Series are available in our standard or heavy-duty construction. These exposed dipole antennas come in both single and dual configurations, depending on the gain required. They are constructed from high strength, corrosion resistant aluminum alloy, hot galvanized steel mounting hardware, and use unique PVC off-set support arms. Our heavy-duty versions have dual support braces and use a superior anti-torque support. All components are oversized.

- Each antenna has a rugged design to withstand the most extreme environmental conditions.
- Supplied with anti-torque supports.
- DC ground for lightning protection.
- Can be black anodized coating for enhanced anti-corrosion and de-icing properties

Electrical Specifications	531-70	531-70HD	532-70	532-70HD
Frequency Range, MHz	30-76	30-76	30-76	30-76
Nominal Gain, dBd	2.5	2.5	5.5	5.5
Bandwidth 1.5:1 VSWR, MHz	7%	7%	7%	7%
Polarization	Vertical	Vertical	Vertical	Vertical
Pattern	Offset	Offset	Offset	Offset
Power Rating, Watts	300	300	300	300
Nominal Impedance, Ohms	50	50	50	50
Lightning Protection	DC Ground	DC Ground	DC Ground	DC Ground
Standard Termination	Type N Male	Type N Male	Type N Male	Type N Male
Mechanical Specifications	531-70	531-70HD	532-70	532-70HD
Length @ 30 MHz, in. (mm)	189 (4800)	189 (4800)	472 (11989)	472 (11989)
Width, in. (mm)	87 (2210)	87 (2210)	87 (2210)	87 (2210)
Weight, lbs. (kg)	37 (17)	43 (19.5)	79 (36)	91 (41)
Rated Wind Velocity, No Ice, mph (km/h)	143 (230)	200 (322)	143 (230)	200 (322)
Rated Wind Velocity, 0.5" (13mm) ice, mph (km/h)	98 (158)	160 (258)	98 (158)	160 (258)
Lateral Thrust @ 100 mph, wind, lbs. (kg)	133 (60.8)	160 (72.3)	266 (121.6)	320 (144.6)
Projected Area, ft ² (m ²)	4.98 (0.46)	5.94 (0.55)	9.96 (0.92)	11.88
Mounting Information Mast O.D., in. (mm)	1.25-2.38 (4)	1.25-2.38 (6)	1.25-2.38 (8)	1.25-2.38 (12)

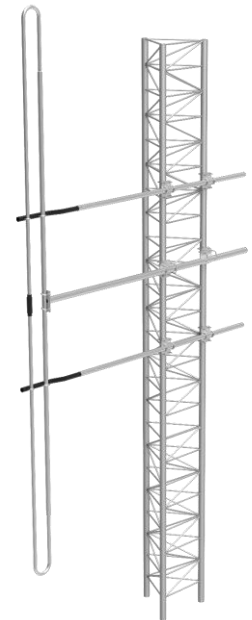

531-70HD

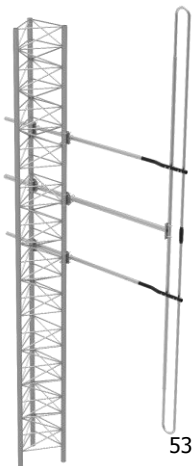

531-70

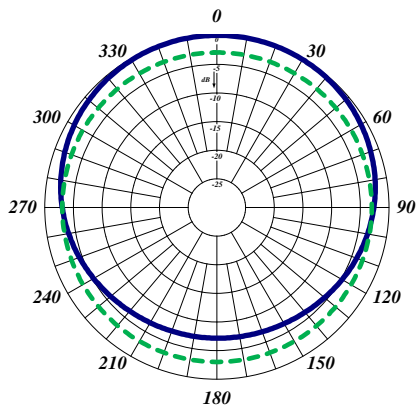

Horizontal Pattern

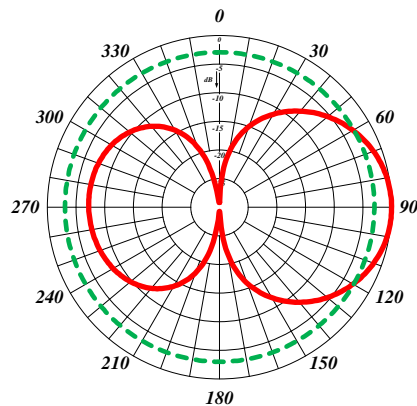

Vertical Pattern

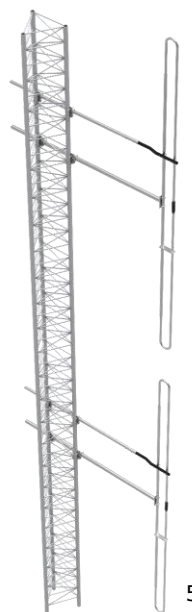

532-70

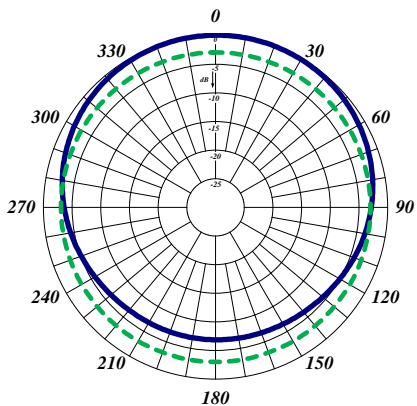

Horizontal Pattern

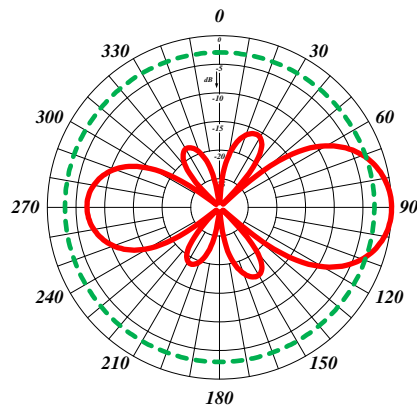

Vertical Pattern

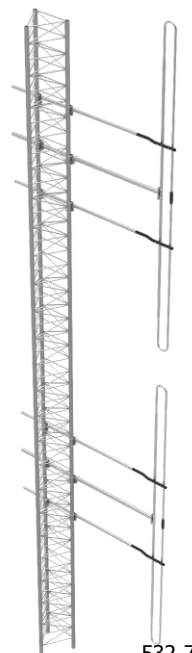

532-70HD

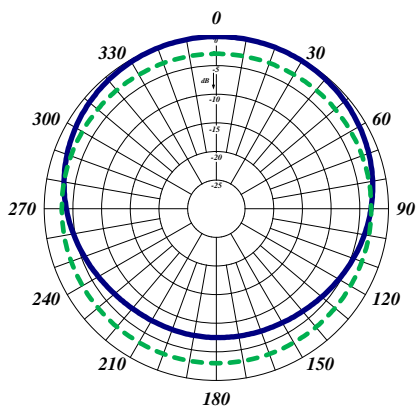

Horizontal Pattern

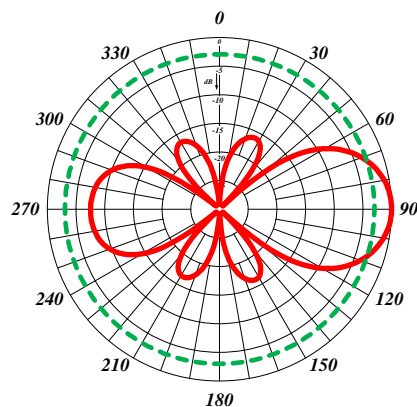

Vertical Pattern

870 Series VHF Exposed Dipoles

The 870 Series VHF Exposed Dipoles are available in 1, 2, 4, 8, dipole and dual dipole configurations. All our antennas can be completely customized to your particular applications. Our antennas can be black anodized, adjustable or fixed, side mount or top mount, and heavy-duty versions are available.

- Each antenna is offered in a 1/4, 3/8, or 1/2 wave spacing versions.
- The 87XA-70 has external cabling and a field-adjustable pattern.
- The 87XF-70 has internal cabling and fixed dipole-mast spacing.
- Heavy-duty versions are available. Please contact our Technical Support team for consultation.

Electrical Specifications	871F-70	872F-70	874F-70
Frequency Range, MHz	138-174	138-174	138-174
Nominal Gain, dBd	2.0-2.5	5.0-5.5	8.0-8.5
Number of Dipoles	1	2	4
Bandwidth 1.5:1 VSWR, MHz	36	36	36
Polarization	Vertical	Vertical	Vertical
Pattern	Offset / bi	Offset / bi	Offset / bi
Power Rating, Watts	200	450	450
Nominal Impedance, Ohms	50	50	50
Lightning Protection	DC Ground	DC Ground	DC Ground
Standard Termination	Type N Male	Type N Male	Type N Male
Mechanical Specifications	871F-70	872F-70	874F-70
Length, in. (mm)	78 (1981)	162 (3200)	246 (6248)
Width (1/2 Wave Spacing), in. (mm)	40 (1016)	40 (1016)	40 (1016)
Weight, lbs. (kg)	13 (6)	24 (10.8)	67 (30)
Rated Wind Velocity, No Ice, mph (km/h)	170 (274)	150 (241)	110 (177)
Rated Wind Velocity, 0.5" (13mm) ice, mph (km/h)	145 (233)	135 (217)	85 (137)
Lateral Thrust @ 100 mph, wind, lbs. (N)	45 (199)	92 (407)	206 (914)
Bending Moment @ top clamp: 100 mph, ft.*lb (N*m)	18 (24)	205 (278)	1440 (1953)
Projected Area, ft ² (m ²)	1.7 (0.16)	3.5 (0.33)	7.7 (0.72)
Mounting Information Mast O.D., in. (mm)	1.9" (48)	2.4" (61)	2.9" (73)



872F-70



871F-70

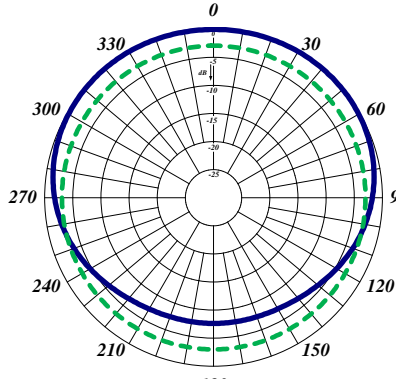

Quarter-wave Spacing Horizontal

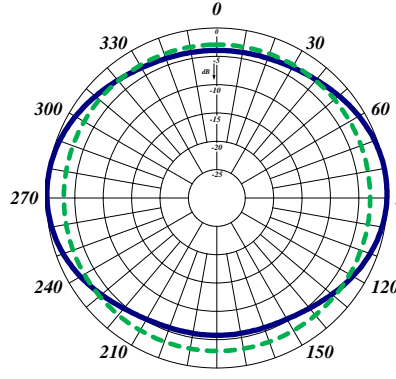

Half-wave Spacing Horizontal

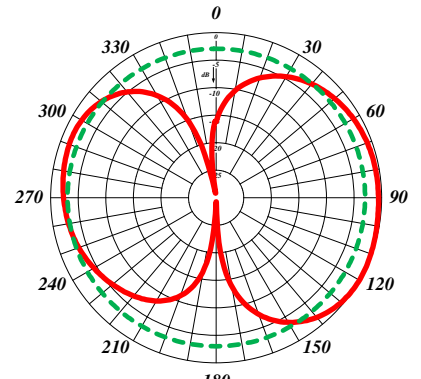

Half-wave Spacing Vertical



872F-70

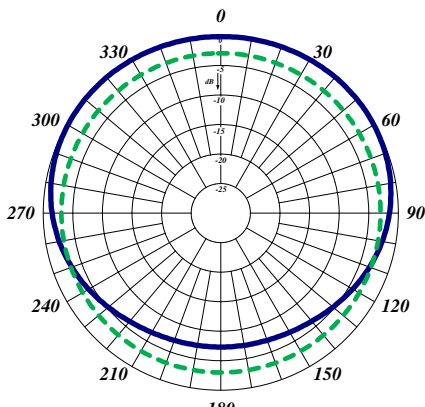

Quarter-wave Spacing Horizontal

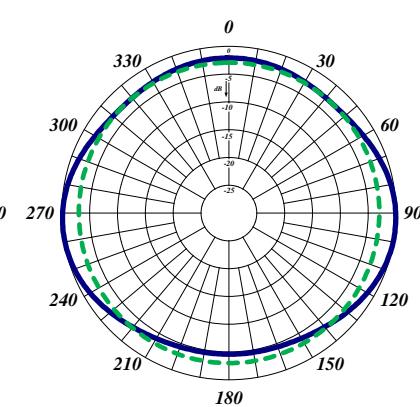

Half-wave Spacing Horizontal

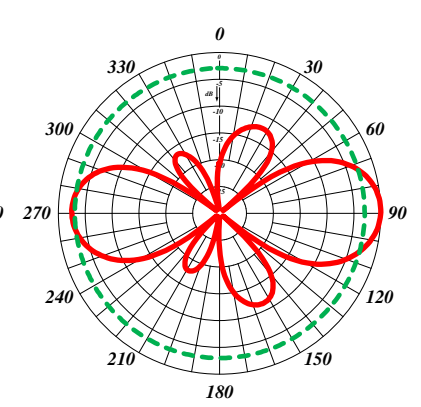

Half-wave Spacing Vertical



874F-70

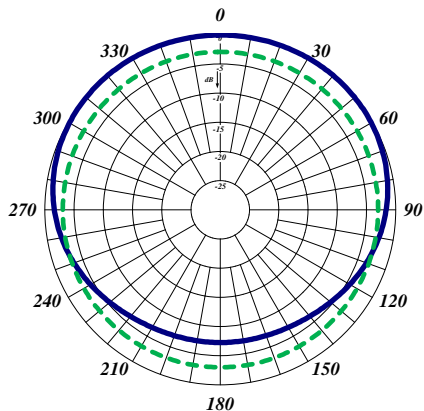

Quarter-wave Spacing Horizontal

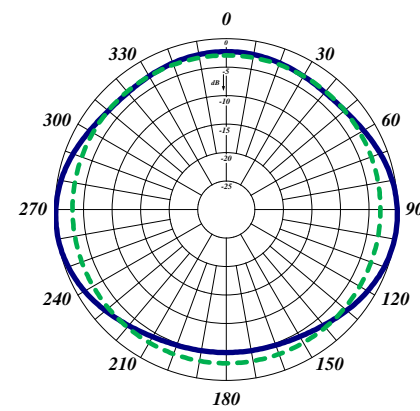

Half-wave Spacing Horizontal

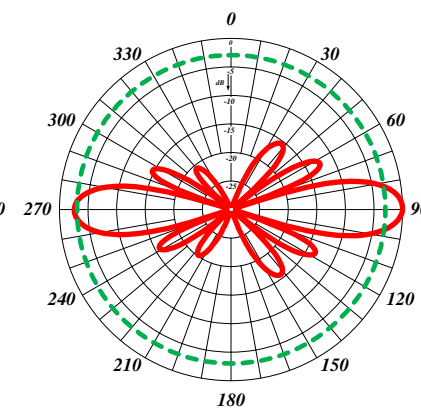

Half-wave Spacing Vertical

870 Series 220MHz Exposed Dipoles

The 870 Series 220MHz Exposed Dipoles are available in 1, 2, 4, 8 dipole configurations. All our antennas can be completely customized to your particular applications. Our antennas can be black anodized, adjustable, or fixed, side mount or top mount, and heavy-duty versions are available.

- Each antenna is offered in a 1/4, 3/8 or 1/2 wave spacing versions.
- The 87XA-70 has external cabling and a field-adjustable pattern.
- The 87XF-70 has internal cabling and fixed dipole-mast spacing.
- Heavy-duty versions are available. Please contact our Technical Support team for consultation.

Electrical Specifications	871F-70-2	872F-70-2	874F-70-2
Frequency Range, MHz	215-225	215-225	215-225
Nominal Gain, dBd	2.0-2.5	5.0-5.5	8.0-8.5
Number of Dipoles	1	2	4
Bandwidth 1.5:1 VSWR, MHz	10	10	10
Polarization	Vertical	Vertical	Vertical
Pattern	Offset / bi	Offset / bi	Offset / bi
Power Rating, Watts	200	300	500
Nominal Impedance, Ohms	50	50	50
Lightning Protection	DC Ground	DC Ground	DC Ground
Standard Termination	Type N Male	Type N Male	Type N Male
Mechanical Specifications	871F-70-2	872F-70-2	874F-70-2
Length, in. (mm)	66 (1676)	112 (2845)	200 (5080)
Width (1/2 Wave Spacing), in. (mm)	31 (787)	31 (787)	32 (813)
Weight, lbs. (kg)	12.5 (5.7)	21 (9.5)	51 (23)
Rated Wind Velocity, No Ice, mph (km/h)	165 (266)	150 (241)	145 (233)
Rated Wind Velocity, 0.5" (13mm) ice, mph (km/h)	140 (225)	130 (209)	105 (177)
Lateral Thrust @ 100 mph, wind, lbs. (kg)	40 (18)	66 (30)	143 (65)
Bending Moment @ top clamp: 100 mph, ft.*lb (kg*m)	58 (8)	150 (21)	610 (84)
Projected Area, ft ² (m ²)	1.5 (0.14)	2.6 (0.24)	5.5 (0.51)
Mounting Information Mast O.D., in. (mm)	1.9 (48)	1.9 (48)	2.4 (60)



872F-70-2



871F-70-2

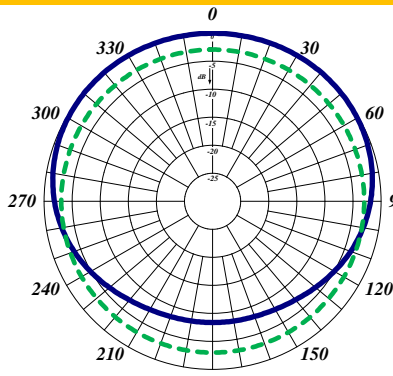

Quarter-wave Spacing Horizontal

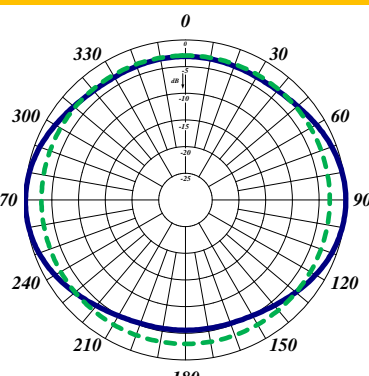

Half-wave Spacing Horizontal

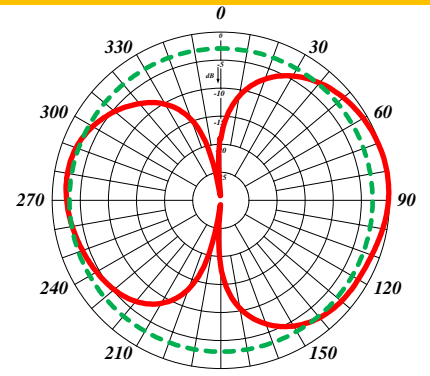

Half-wave Spacing Vertical



872F-70-2

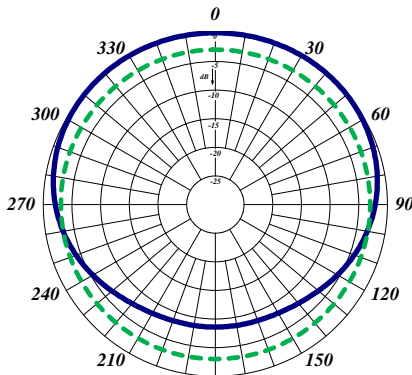

Quarter-wave Spacing Horizontal

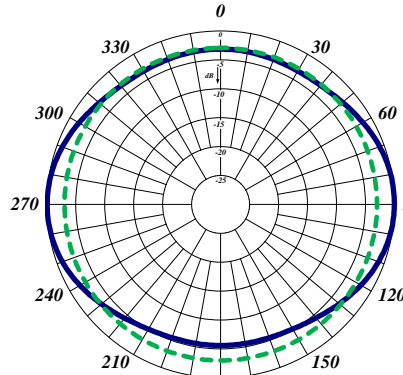

Half-wave Spacing Horizontal

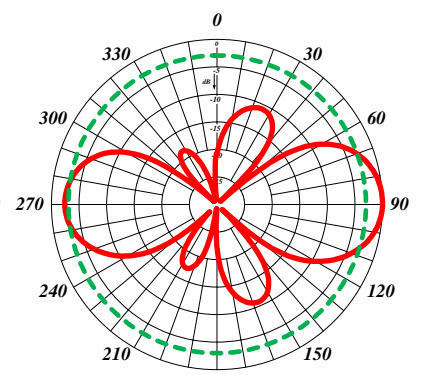

Half-wave Spacing Vertical



874F-70-2

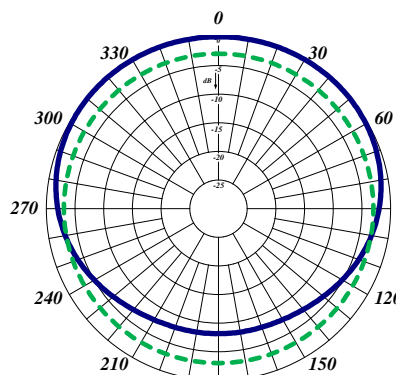

Quarter-wave Spacing Horizontal

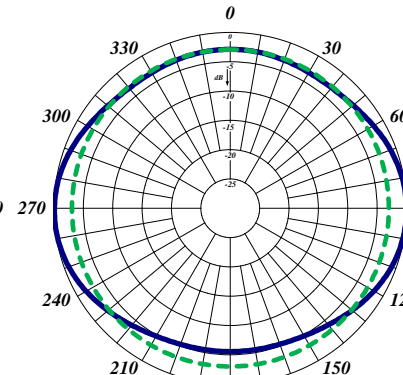

Half-wave Spacing Horizontal

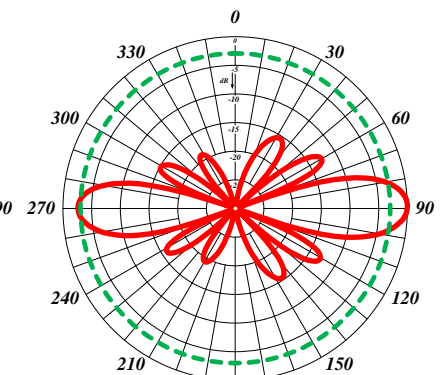

Half-wave Spacing Vertical

860 Series 160/220MHz Exposed Dipoles

The 860 Series consists of Dual Band Dipoles and are available in 1, 2 and 4 dipole configurations. All our antennas can be completely customized to your particular applications. Our antennas can be black anodized, side mount or top mount and heavy-duty versions are available.

- The 86XF-70 antenna has an internal cabling and fixed dipole-mast spacing.
- Please contact our Technical Support team for consultation.

Electrical Specifications	861F-70	862F-70	866F-70SM
Frequency Range, MHz	158-168 & 215-225	158-168 & 215-225	155-165 & 215-225
Nominal Gain, dBd	2.0-2.5	5.0-5.5	5.0-5.5
Number of Dipoles	1	2	2 sets of 2
Bandwidth 1.5:1 VSWR, MHz	10	10	10
Polarization	Vertical	Vertical	Vertical
Pattern	Offset	Offset	Offset
Power Rating, Watts	300	300	300
Nominal Impedance, Ohms	50	50	50
Lightning Protection	DC Ground	DC Ground	DC Ground
Standard Termination	Type N Male	Type N Male	Type N Male
Mechanical Specifications	861F-70	862F-70	866F-70SM
Length, in. (mm)	77 (1975)	112 (2845)	240 (6096)
Width (1/2 Wave Spacing), in. (mm)	31 (787)	31 (787)	36 (914)
Weight, lbs. (kg)	14.5 (6.5)	21 (9.5)	55 (25)
Rated Wind Velocity, No Ice, mph (km/h)	150 (241)	150 (241)	155 (249)
Rated Wind Velocity, 0.5" (13mm) ice, mph (km/h)	130 (209)	130 (209)	125 (201)
Lateral Thrust @ 100 mph, wind, lbs. (kg)	66 (30)	66 (30)	172 (78)
Projected Area, ft ² (m ²)	2.6 (0.24)	2.6 (0.24)	5.8 (0.54)
Mounting Information Mast O.D., in. (mm)	1.9 (48)	1.9 (48)	2.88 (73)





861F-70

Horizontal Pattern (160MHz)

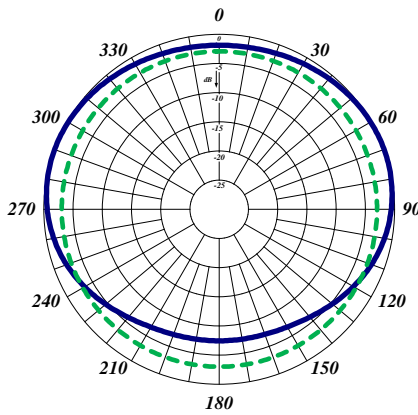

Vertical Pattern (160MHz)

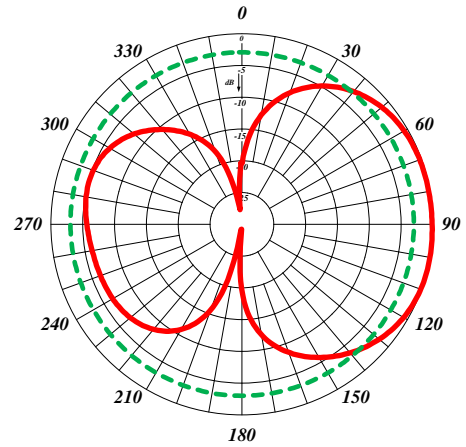

Horizontal Pattern (220MHz)

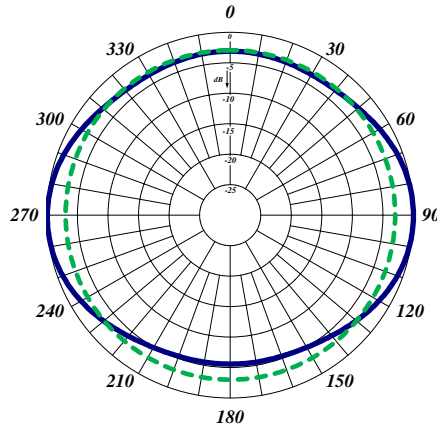

Vertical Pattern (220MHz)

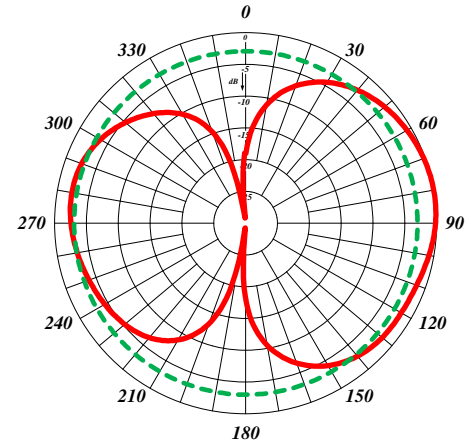

862F-70

Horizontal Pattern (160MHz)

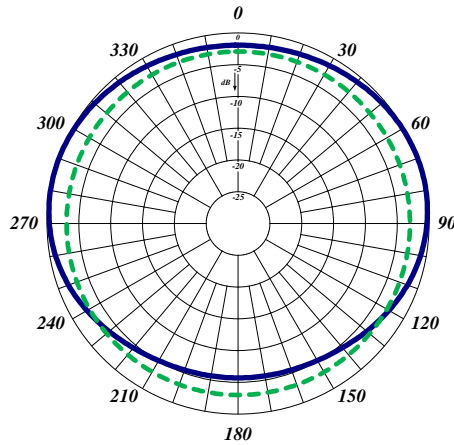

Vertical Pattern (160MHz)

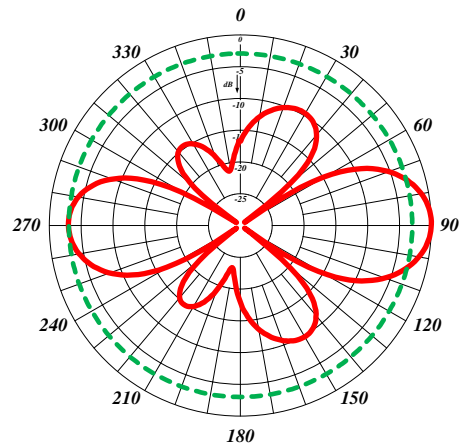



862F-70

Horizontal Pattern (220MHz)

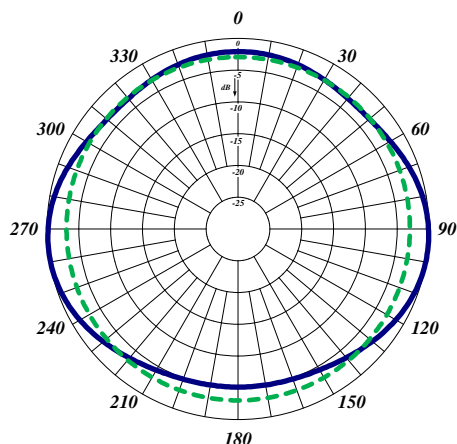

Vertical Pattern (220MHz)

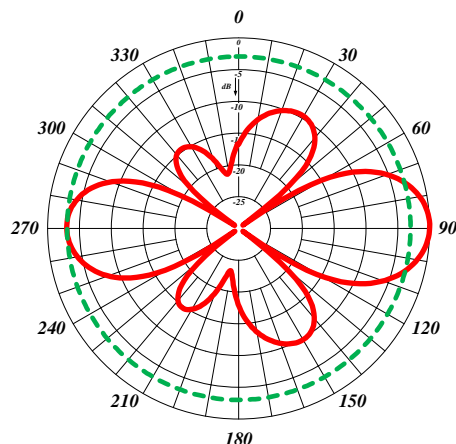

866F-70SM

Horizontal Pattern (160MHz)

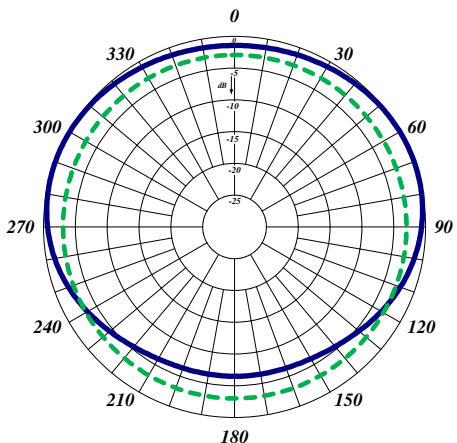

Vertical Pattern (160MHz)

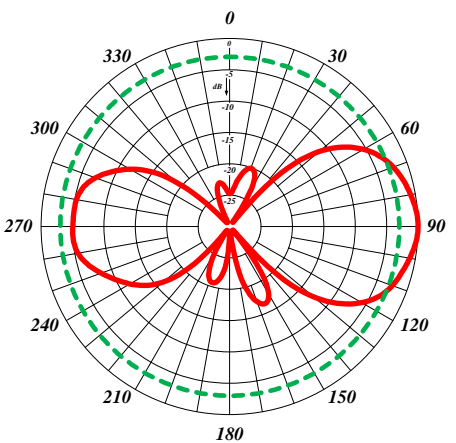

Horizontal Pattern (220MHz)

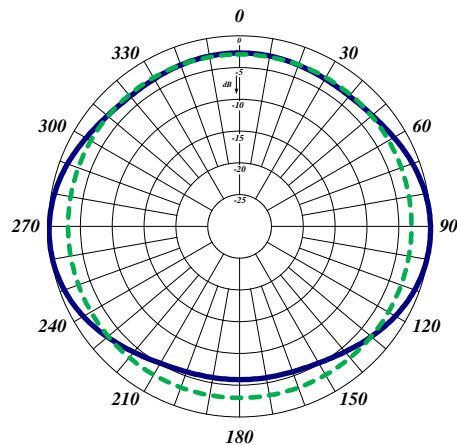

Vertical Pattern (220MHz)

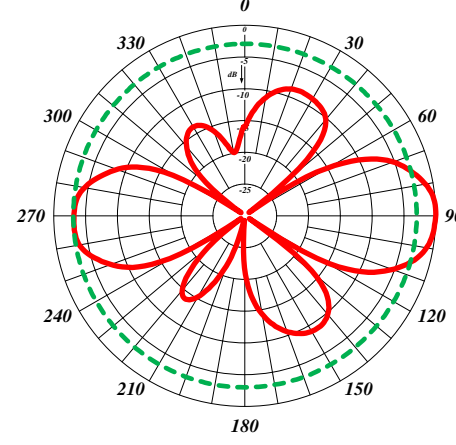

770 Series UHF Exposed Dipoles

The 770 Series UHF Exposed Dipoles are available in 1, 2, 4, 8 and dual dipole configurations. All our antennas can be completely customized to your particular applications. Our antennas can be black anodized, adjustable or fixed, side mount or top mount, and heavy-duty versions are available.

- Each antenna is offered in a 1/4, 3/8, or 1/2 wave versions.
- The 77X-70 has internal cabling and fixed dipole-mast spacing.
- Heavy-duty Versions are available. Please contact our Technical Support team for consultation.

Electrical Specifications	771-70	772-70	774-70	778-70
Frequency Range, MHz	406-512	406-512	406-512	406-512
Nominal Gain, dBd	2.0-2.5	5.0-5.5	8.0-8.5	11.0-11.5
Number of Dipoles	1	2	4	8
Bandwidth 1.5:1 VSWR, MHz	106	106	106	64
Polarization	Vertical	Vertical	Vertical	Vertical
Pattern	Offset / Bi	Offset / Bi	Offset / Bi	Offset / Bi
Power Rating, Watts	75	150	300	300
Nominal Impedance, Ohms	50	50	50	50
Lightning Protection	DC Ground	DC Ground	DC Ground	DC Ground
Standard Termination	Type N Male	Type N Male	Type N Male	Type N Male
Mechanical Specifications	771-70	772-70	774-70	778-70
Length, in. (mm)	66 (1676)	86 (2184)	126 (3200)	210 (5334)
Width, in. (mm)	16 (406)	16 (406)	16 (406)	17 (432)
Weight, lbs. (kg)	8.6 (3.9)	12.6 (5.7)	21 (9.5)	52 (23.6)
Rated Wind Velocity, No Ice, mph (km/h)	170 (274)	160 (257)	150 (241)	140 (225)
Rated Wind Velocity, 0.5" (13mm) ice, mph (km/h)	145 (233)	135 (217)	120 (193)	105 (169)
Lateral Thrust @ 100 mph, wind, lbs. (kg)	27 (12.3)	39 (17.8)	64 (29)	134 (61)
Bending Moment @ top clamp: 100 mph, ft.*lb (kg*m)	33.5 (4.6)	72 910)	177 (24.5)	655 (91)
Projected Area, ft ² (m ²)	1 (0.09)	1.5 (0.14)	2.4 (0.23)	5.1 (0.472)
Mounting Information: Mast O.D., in. (mm)	1.9 (48)	1.9 (48)	1.9 (48)	2.4 (61)





771-70

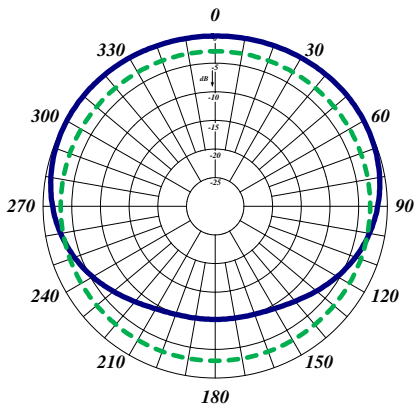

Quarter-wave Spacing Horizontal

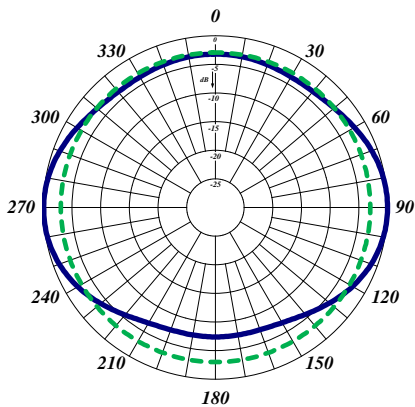

Half-wave Spacing Horizontal

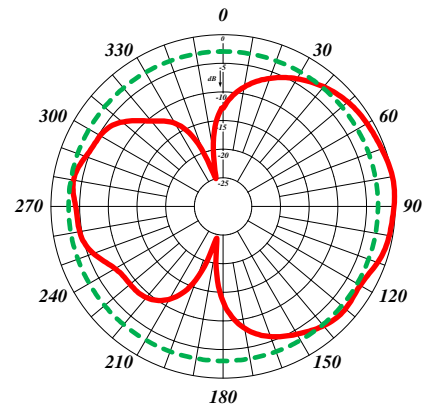

Half-wave Spacing Vertical



772-70

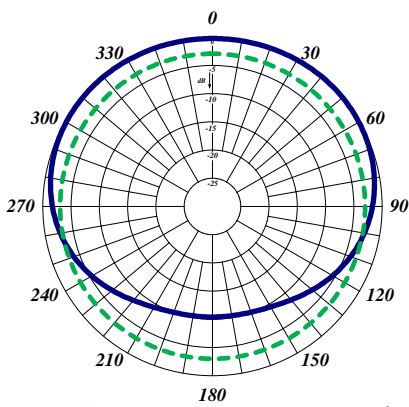

Quarter-wave Spacing Horizontal

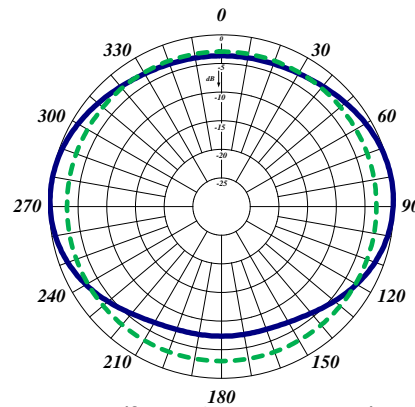

Half-wave Spacing Horizontal

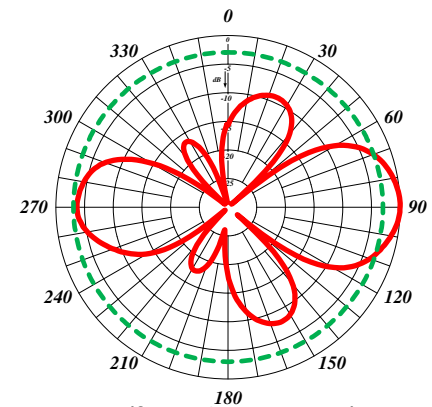

Half-wave Spacing Vertical



774-70

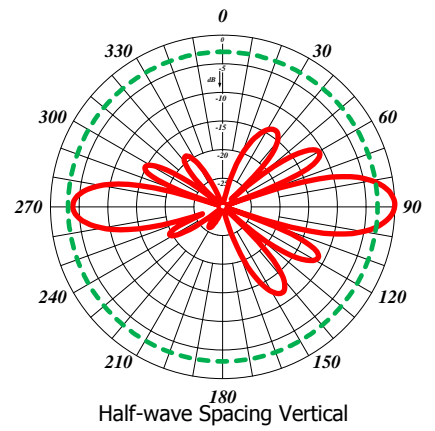
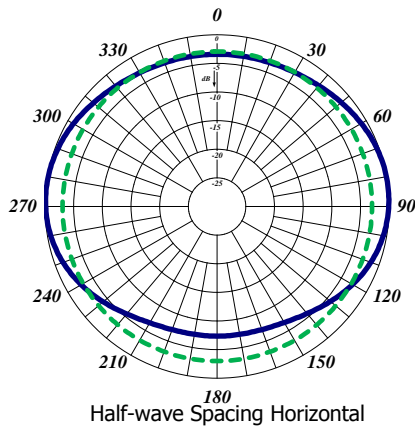
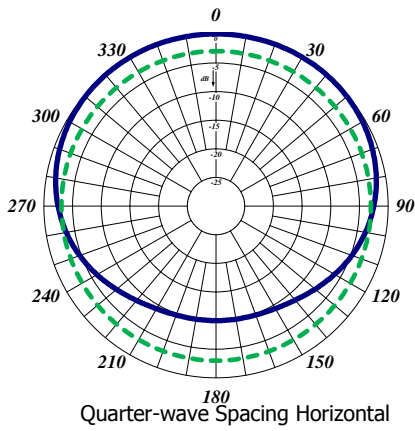

778-70

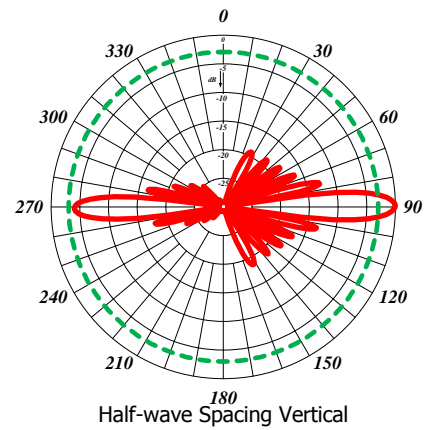
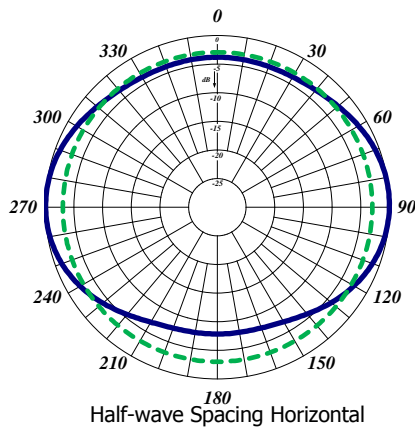
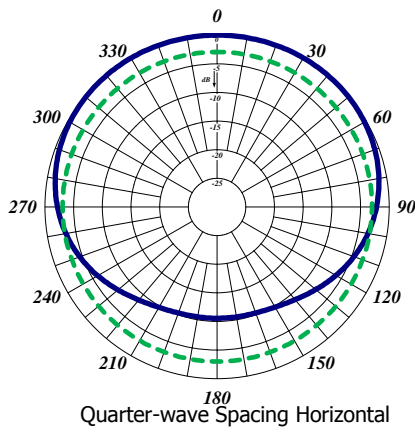

290 Series VHF Yagi Antennas

The 290 Series VHF Yagi Antenna are available in 2, 3, and 6 element configurations. All our antennas can be completely customized to your applications. Our antennas can be black anodized, welded, vertically or horizontally polarized, and heavy-duty versions are available.

- Each antenna has a rugged design to withstand harsh environmental conditions.
- The mounting hardware supplied will permit either vertical or horizontal polarization.
- DC ground for lightning protection.
- Optionally have the entire antenna welded for added durability.
- Heavy-duty versions are available. Please contact our Technical Support team for consultation.

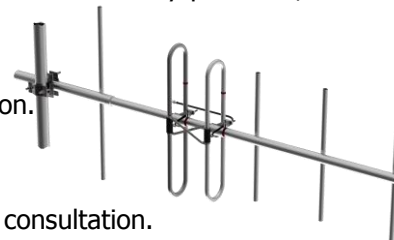

250-70

Electrical Specifications	291-70	295-70	290-70	250-70
Frequency Range, MHz	138-174	138-174	138-174	138-174
Nominal Gain, dBd	3.5	6.5	9.5	7
Number of Elements	2	3	6	7
Bandwidth 2.0:1 VSWR, MHz (Ctr. Freq.%)	36	4%	4%	36
Polarization	Vert. or Horiz.	Vert. or Horiz.	Vert. or Horiz.	Vert. or Horiz.
Horizontal Beamwidth (Horizontal Pol.)	140°	90°	62°	80°
Vertical Beamwidth (Horizontal Pol.)	70°	61°	50°	60°
Front to Back, dB	15	12	17	25
Pattern	Directional	Directional	Directional	Directional
Power Rating, Watts	350	350	350	250
Nominal Impedance, Ohms	50	50	50	50
Lightning Protection	DC Ground	DC Ground	DC Ground	DC Ground
Standard Termination	Type N Male	Type N Male	Type N Male	Type N Male
Mechanical Specifications	291-70	295-70	290-70	250-70
Length, in. (mm)	50 (1270)	60 (1524)	108 (2743)	104 (2642)
Width (1/2 Wave Spacing), in. (mm)	40 (1016)	43 (1092)	42 (1067)	42 (1067)
Weight, lbs. (kg)	4.8 (2.2)	6.5 (2.9)	12.0 (5.4)	12.0 (5.4)
Rated Wind Velocity, No Ice, mph (km/h)	150 (241)	145 (223)	120 (177)	110 (177)
Rated Wind Velocity, 0.5" (13mm) ice, mph (km/h)	105 (169)	100 (161)	85 (137)	90 (145)
Lateral Thrust @ 100 mph, wind, lbs. (kg)	29 (13)	39 (18)	65 (29)	95 (43)
Projected Area, ft ² (m ²)	1.1 (0.10)	1.4 (0.13)	2.4 (0.22)	2.6 (0.24)
Mounting Hardware Included	181-85 Clamp	181-85 Clamp	115-85 Clamp	115-85 Clamp



291-70

Horizontal Pattern

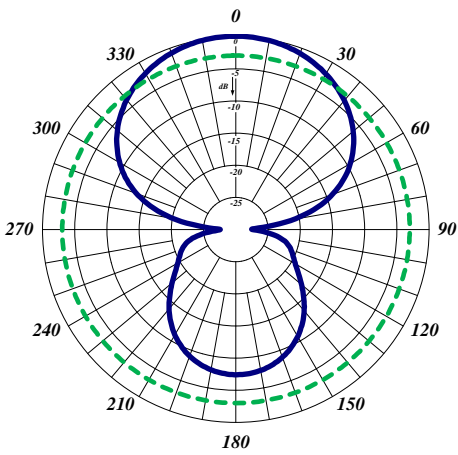

Horizontal Polarization

Vertical Pattern

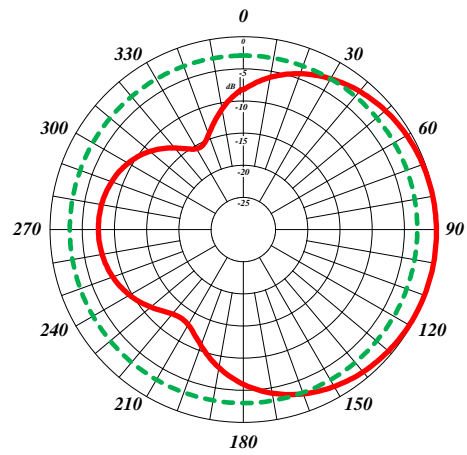

295-70

Horizontal Pattern

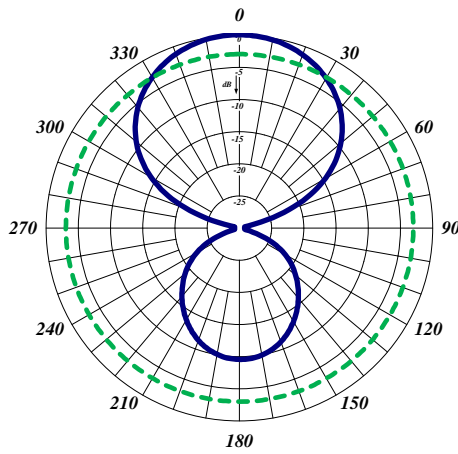

Vertical Pattern

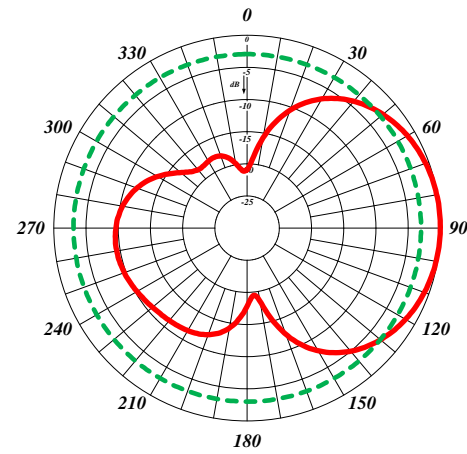

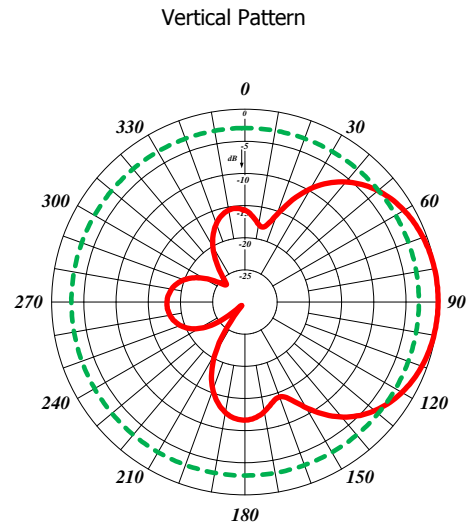
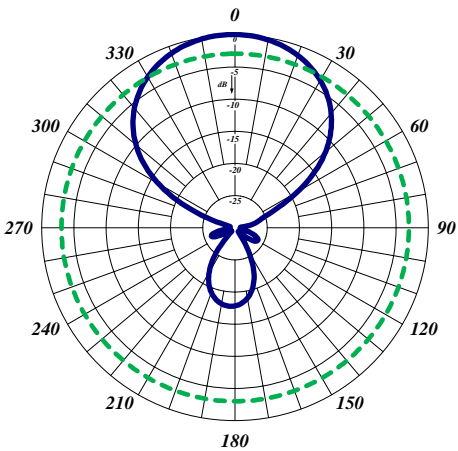
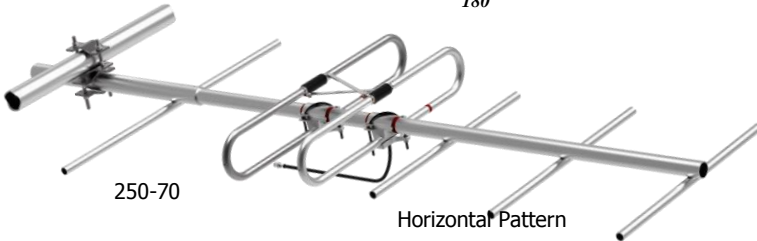
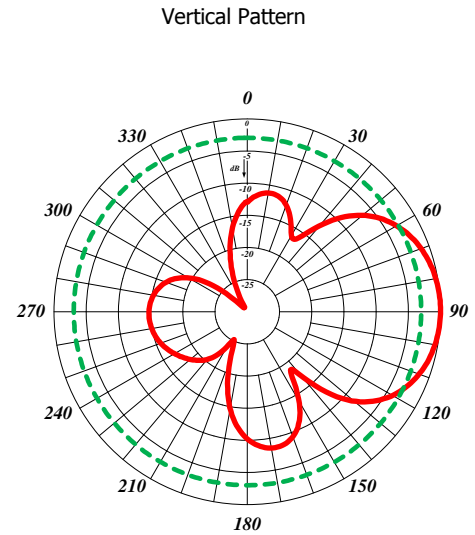
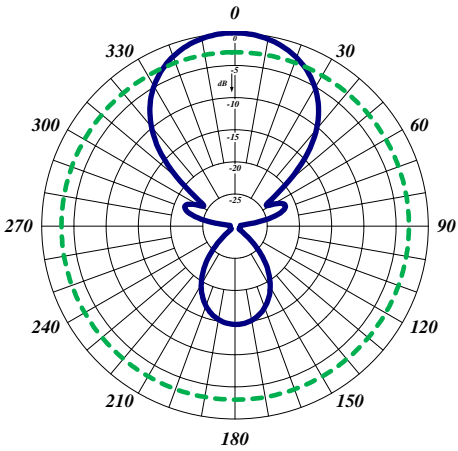

290 Series 220MHz Yagi Antennas

The 290 Series 220MHz Yagi Antennas are available in 2, 3, and 6 element configurations. All our antennas can be completely customized to your particular applications. Our antennas can be black anodized, welded, vertically or horizontally polarized, and heavy-duty versions are available.

- Each antenna has a rugged design to withstand harsh environmental conditions.
- The mounting hardware supplied will permit either vertical or horizontal polarization.
- DC ground for lightning protection.
- Option to have the entire antenna welded for added durability.
- Heavy-duty versions are available. Please contact our Technical Support team for consultation.

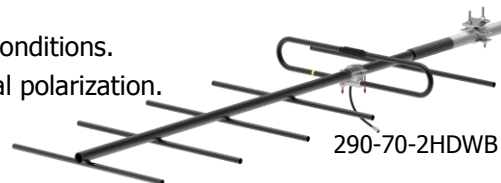

Electrical Specifications	291-70-2	295-70-2	290-70-2
Frequency Range, MHz	215-225	215-225	215-225
Nominal Gain, dBd	3.5	6.5	9.5
Number of Elements	2	3	6
Bandwidth 1.5:1 VSWR, MHz (Center Freq.%)	10	10	10
Polarization	Vert. or Horiz.	Vert. or Horiz.	Vert. or Horiz.
Horizontal Beamwidth (Horizontal Pol.)	140°	90°	62°
Vertical Beamwidth (Horizontal Pol.)	70°	36°	50°
Front to Back, dB	15	12	17
Pattern	Directional	Directional	Directional
Power Rating, Watts	350	350	350
Nominal Impedance, Ohms	50	50	50
Lightning Protection	DC Ground	DC Ground	DC Ground
Standard Termination	Type N Male	Type N Male	Type N Male
Mechanical Specifications	291-70-2	295-70-2	290-70-2
Length, in. (mm)	32 (813)	48 (1219)	84 (2134)
Width (1/2 Wave Spacing), in. (mm)	29 (737)	28 (711)	27 (686)
Weight, lbs. (kg)	3.7 (1.7)	4.8 (2.2)	9.0 (4.1)
Rated Wind Velocity, No Ice, mph (km/h)	165 (266)	155 (249)	145 (233)
Rated Wind Velocity, 0.5" (13mm) ice, mph (km/h)	145 (233)	130 (209)	100 (161)
Lateral Thrust @ 100 mph, wind, lbs. (kg)	19.4 (8.8)	27 (12)	47 (21.3)
Torsional Moment @ 100 mph, ft.*lb (kg*m)	25 (3.5)	52 (7.2)	138 (19)
Projected Area, ft ² (m ²)	0.7 (0.07)	1.0 (0.09)	1.75 (0.16)
Mounting Hardware Included	181-85 Clamp	181-85 Clamp	115R-85 Clamp

Horizontal Polarization

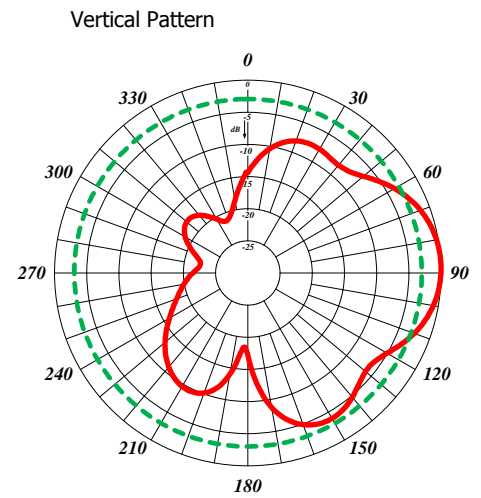
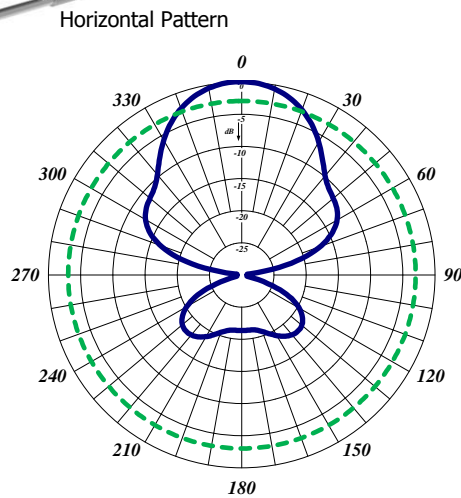
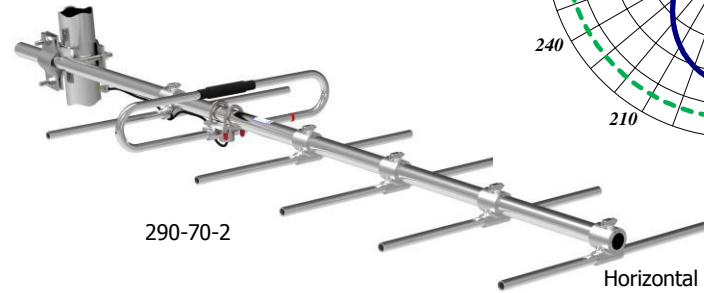
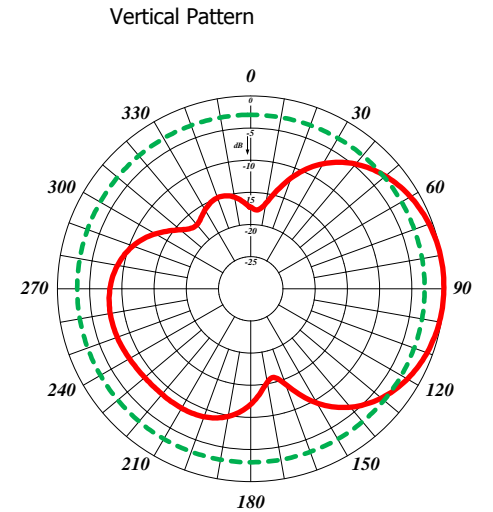
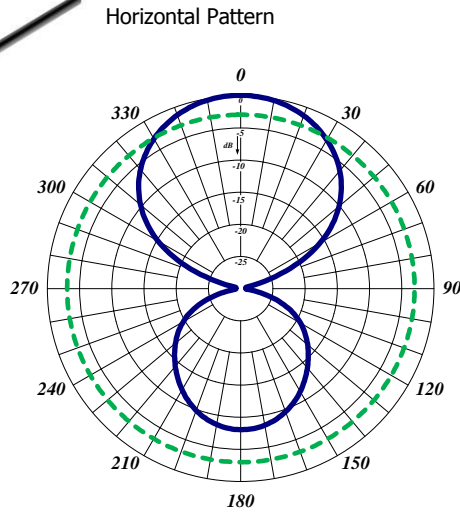
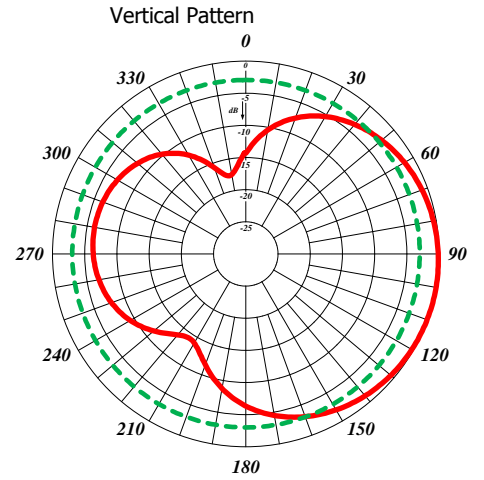
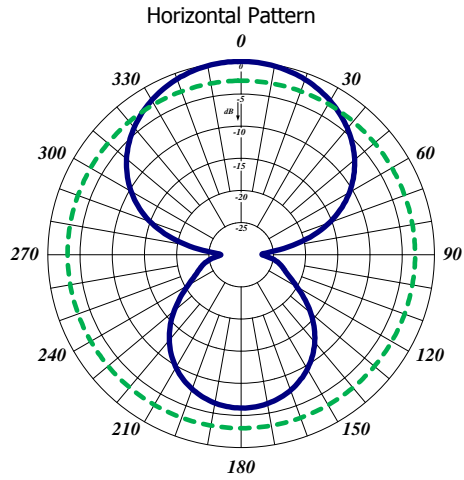
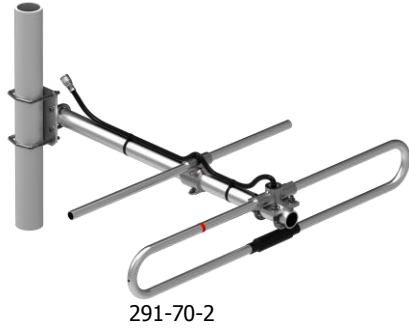

F-33324 Back to Back Dual Yagi Antenna Array

The F-33324 is a dual Yagi array mounted in a back-to-back configuration. The antennas are welded and are supplied with a phasing harness. All our antennas can be completely customized to your particular applications. Our antennas can be vertically or horizontally polarized and heavy-duty versions are available.

- Each antenna has a rugged design to withstand harsh environmental conditions.
- The mounting hardware supplied will permit either vertical or horizontal polarization.
- DC ground for lightning protection.
- Heavy-duty versions are available. Please contact our Technical Support team for consultation.

Electrical Specifications	F-33324
Frequency Range, MHz	215-225
Nominal Gain, dBd	6.6
Bandwidth 1.5:1 VSWR, MHz (Center Freq.%)	10
Polarization	Vert. or Horiz.
Horizontal Beamwidth (Vert. Pol.)	47°
Vertical Beamwidth (Vert. Pol.)	43°
Front to Back, dB	N/A
Pattern	Directional
Power Rating, Watts	350
Nominal Impedance, Ohms	50
Lightning Protection	DC Ground
Standard Termination	Type N Male
Mechanical Specifications	F-33324
Length, in. (mm)	161 (4089)
Width, in. (mm)	27 (686)
Weight, lbs. (kg)	28 (12.7)
Rated Wind Velocity, No Ice, mph (km/h)	145 (233)
Rated Wind Velocity, 0.5" (13mm) ice, mph (km/h)	100 (161)
Lateral Thrust @ 100 mph, wind, lbs. (kg)	94 (418)
Projected Area, ft ² (m ²)	4.0 (0.37)
Mounting Hardware Included	115R-85 Clamp



F-33324HD

Horizontal Pattern

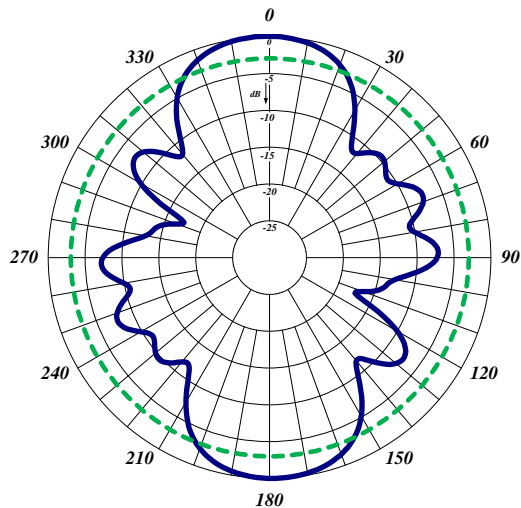

Vertical Pattern

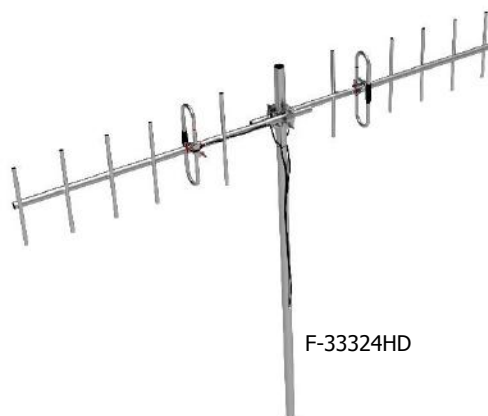
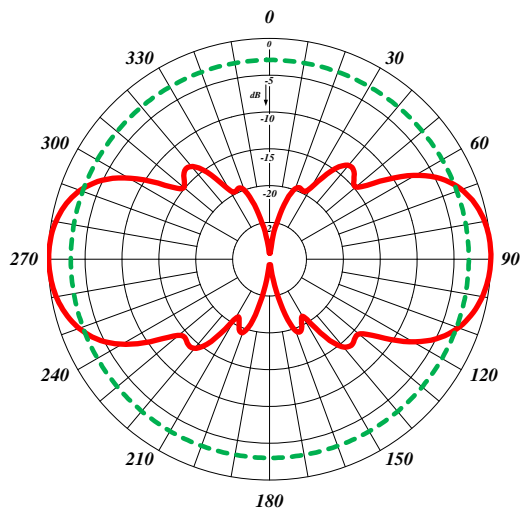

F-33324HD

UHF Yagi Antennas Series

The UHF Yagi Antenna Series is available in 2, 3, 7 elements and our 70 MHz wideband configurations. All our antennas can be completely customized to your particular applications. Our antennas can be black anodized, fully welded, vertically or horizontally polarized, and heavy-duty versions are available.

- Each antenna has a rugged, fully welded design to withstand harsh environmental conditions.
- The mounting hardware supplied allows either vertical or horizontal polarization.
- DC ground for lightning protection.
- Heavy-duty versions are available. Please contact our Technical Support team for consultation.

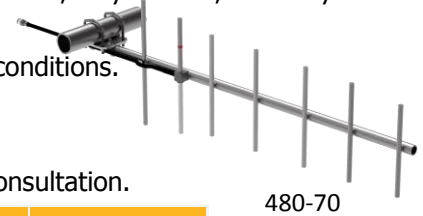

Electrical Specifications	F-3872	433-70	430-70	480-70
Frequency Range, MHz	406-512	406-512	406-512	406-470
Nominal Gain, dBd	3.5	6.5	10.0	10.0
Number of Elements	2	3	7	7
Bandwidth 1.5:1 VSWR, MHz (Center Freq.%)	24	24	24	64
Polarization	Vert. or Horiz.	Vert. or Horiz.	Vert. or Horiz.	Vert. or Horiz.
Horizontal Beamwidth (Vert. Pol.)	138°	83°	62°	62°
Vertical Beamwidth (Vert. Pol.)	72°	59°	48°	50°
Front to Back, dB	10	12	20	17
Pattern	Directional	Directional	Directional	Directional
Power Rating, Watts	350	350	350	350
Nominal Impedance, Ohms	50	50	50	50
Lightning Protection	DC Ground	DC Ground	DC Ground	DC Ground
Standard Termination	Type N Male	Type N Male	Type N Male	Type N Male
Mechanical Specifications	F-3872	433-70	430-70	480-70
Length, in. (mm)	28 (711)	23 (584)	45 (1143)	45 (1143)
Width (1/2 Wave Spacing), in. (mm)	14.5 (368)	14 (355)	14.5 (368)	14.4 (366)
Weight, lbs. (kg)	2.8 (1.3)	2.9 (1.3)	3.9 (1.8)	3.9 (1.8)
Rated Wind Velocity, No Ice, mph (km/h)	160 (257)	160 (257)	150 (241)	150 (241)
Rated Wind Velocity, 0.5" (13mm) ice, mph (km/h)	120 (193)	120 (193)	110 (177)	110 (177)
Lateral Thrust @ 100 mph, wind, lbs. (kg)	9 (4.1)	8.7 (4.0)	16 (7.3)	15 (6.8)
Projected Area, ft ² (m ²)	0.34 (0.03)	0.32 (0.03)	0.61 (0.06)	0.55 (0.05)
Mounting Hardware Included	127-85 Clamp	127-85 Clamp	127-85 Clamp	127-85 Clamp

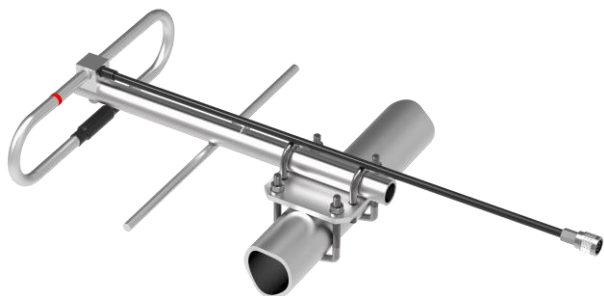

F-3872

Horizontal Polarization

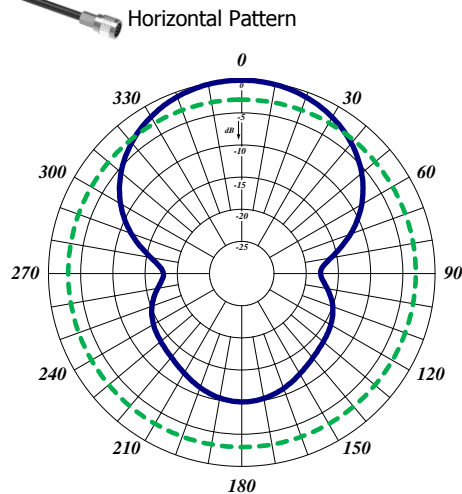

Vertical Pattern

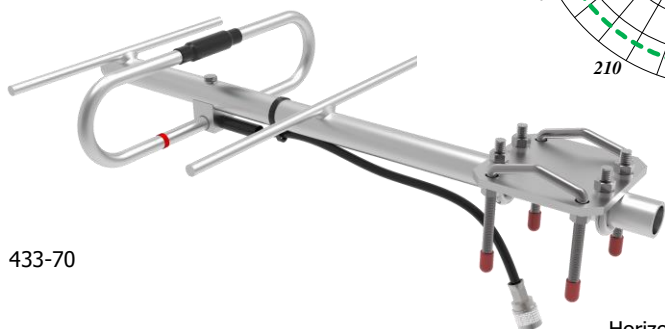
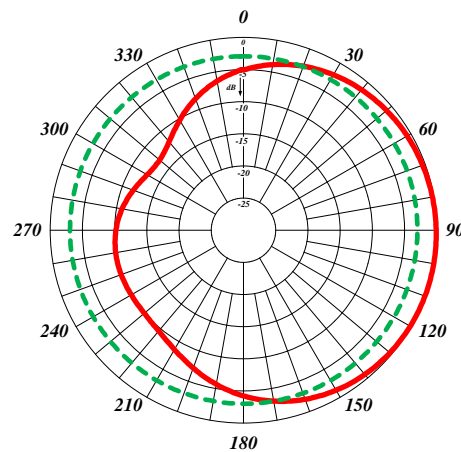

433-70

Horizontal Polarization

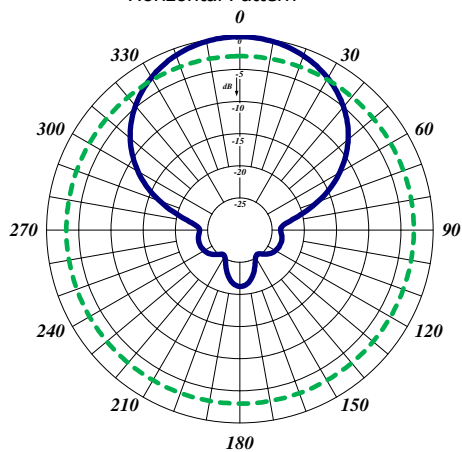

Vertical Pattern

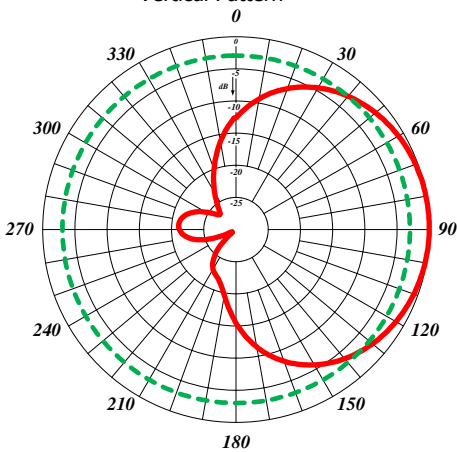

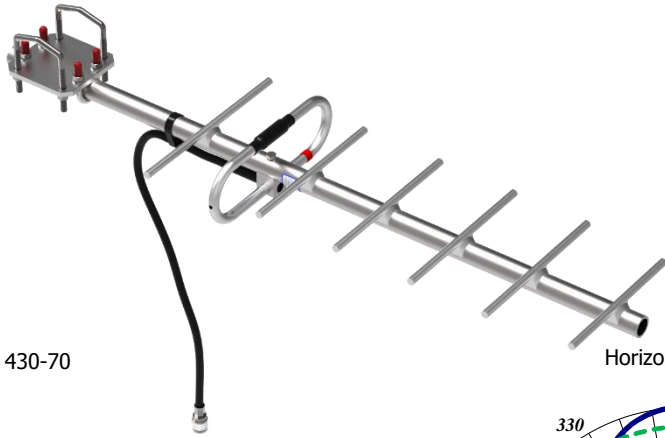

430-70

Horizontal Polarization

Horizontal Pattern

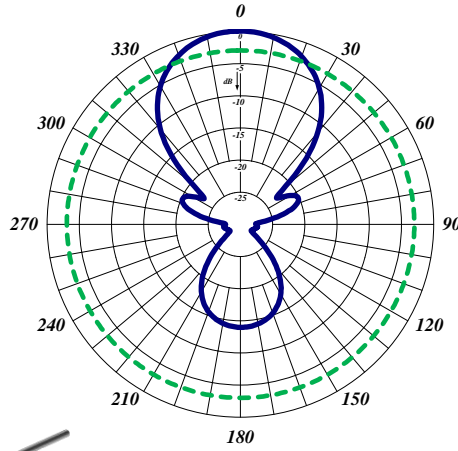

Vertical Pattern

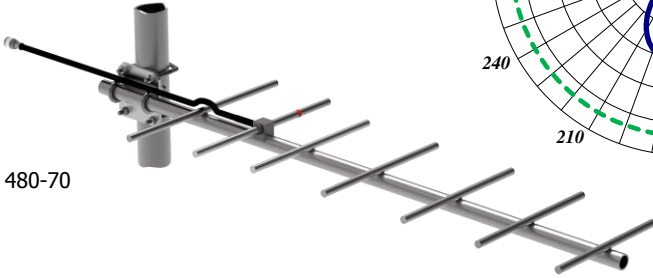
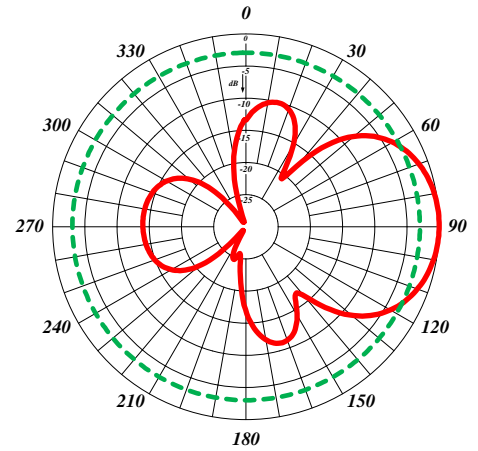

480-70

Horizontal Pattern

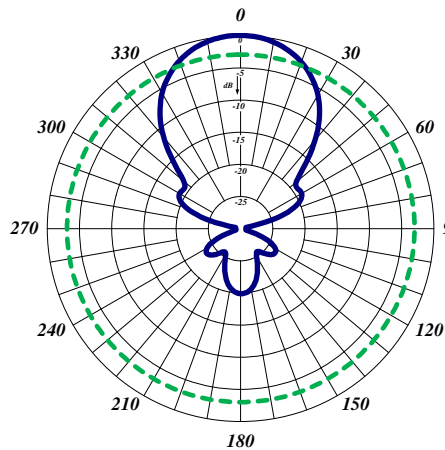

Vertical Pattern

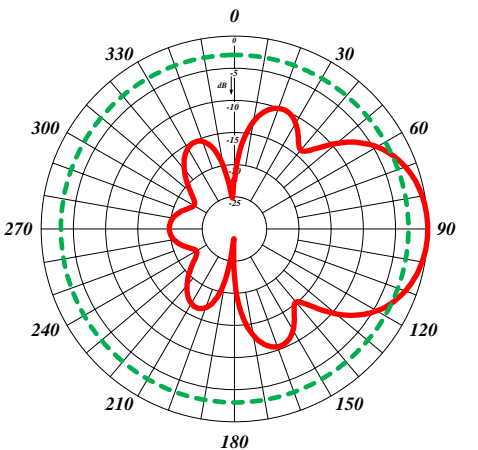

980 Yagi Antennas Series

The 980 Yagi Antenna Series are available in 2, 3, 7, 12 element configurations. All our antennas can be completely customized to your particular applications. Our antennas can be black anodized, vertically or horizontally polarized.

- Each antenna has a rugged design to withstand harsh environmental conditions.
- The mounting hardware supplied will permit either vertical or horizontal polarization.
- All 980 Series Yagi antennas are fully welded.
- Heavy-duty versions are available. Please contact our Technical Support team for consultation.



Electrical Specifications	982-70	983-70	980-70	987-70
Frequency Range, MHz	900-930	746-960	746-960	746-960
Nominal Gain, dBd	3.5	6.5	10.0	12.0
Number of Elements	2	3	7	12
Bandwidth 1.5:1 VSWR, MHz (Ctr. Freq.%)	30	85	85	85
Polarization	Vert. or Horiz.	Vert. or Horiz.	Vert. or Horiz.	Vert. or Horiz.
Horizontal Beamwidth (Horizontal Pol.)	128°	99°	56°	41°
Vertical Beamwidth (Horizontal Pol.)	66°	60°	42°	38°
Front to Back, dB	9	16	20	20
Pattern	Directional	Directional	Directional	Directional
Power Rating, Watts	200	200	200	200
Nominal Impedance, Ohms	50	50	50	50
Standard Termination	Type N Male	Type N Male	Type N Male	Type N Male
Mechanical Specifications	982-70	983-70	980-70	987-70
Length, in. (mm)	11 (280)	13 (330)	27 (686)	41 (1041)
Width (1/2 Wave Spacing), in. (mm)	6.5 (165)	8 (203)	8 (203)	8 (203)
Weight, lbs. (kg)	1.7 (0.76)	1.8 (0.82)	2.5 (1.1)	3 (1.4)
Rated Wind Velocity, No Ice, mph (km/h)	160 (257)	160 (257)	150 (241)	140 (225)
Rated Wind Velocity, 0.5" (13mm) ice, mph (km/h)	120 (193)	120 (193)	110 (177)	100 (161)
Lateral Thrust @ 100 mph, wind, lbs.(kg)	2.6 (1.2)	2.8 (1.3)	7 (3.2)	11 (5.0)
Projected Area, ft ² (m ²)	0.10	0.13	0.26	0.41
Mounting Hardware Included	127-85 Clamp	127-85 Clamp	127-85 Clamp	127-85 Clamp

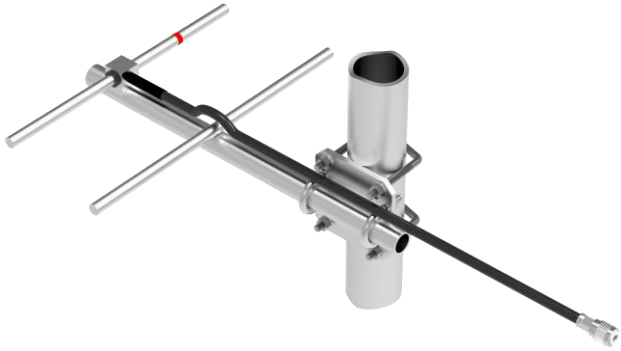

982-70

Horizontal Polarization

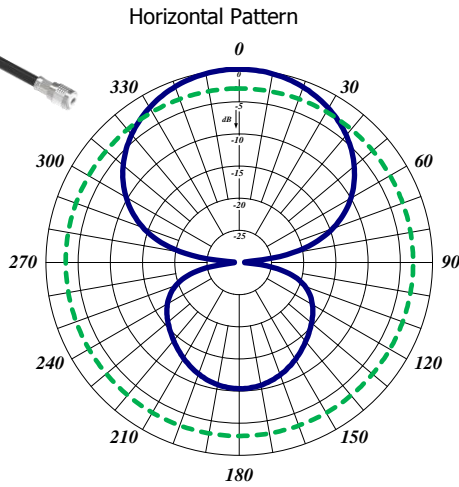

Vertical Pattern

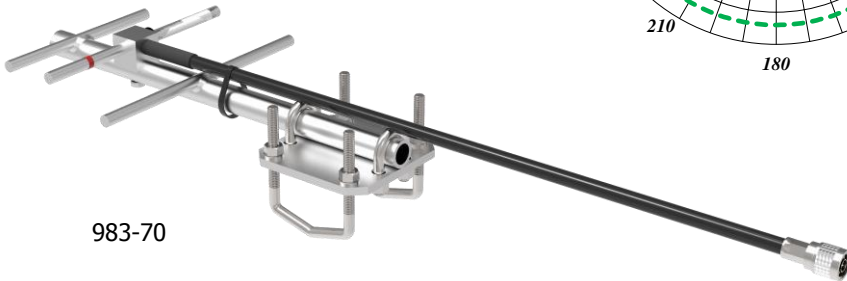
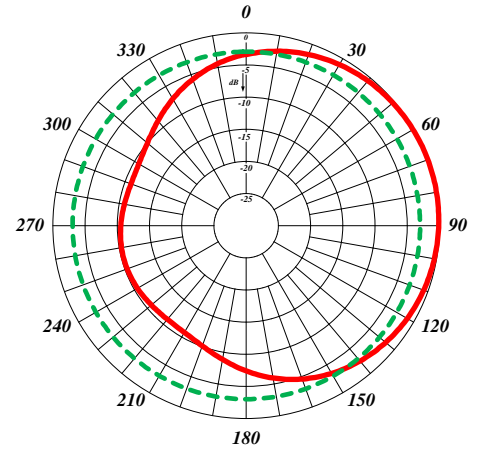

983-70

Horizontal Polarization

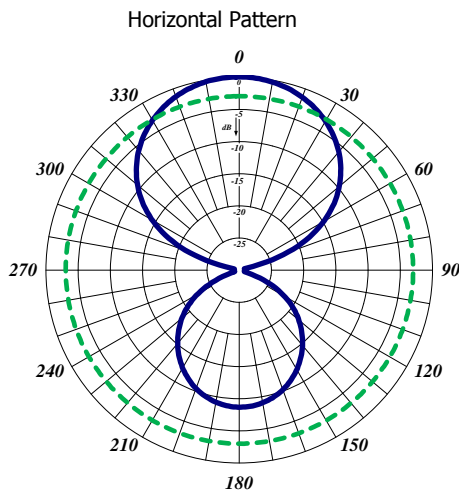

Vertical Pattern

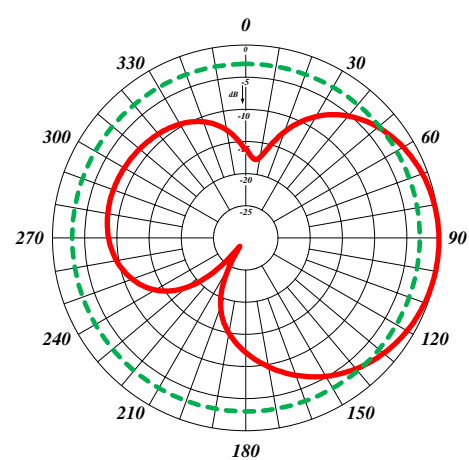

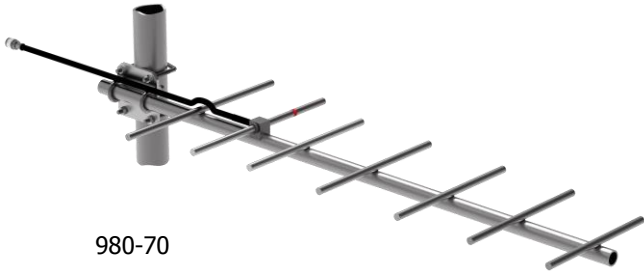

980-70

Horizontal Polarization

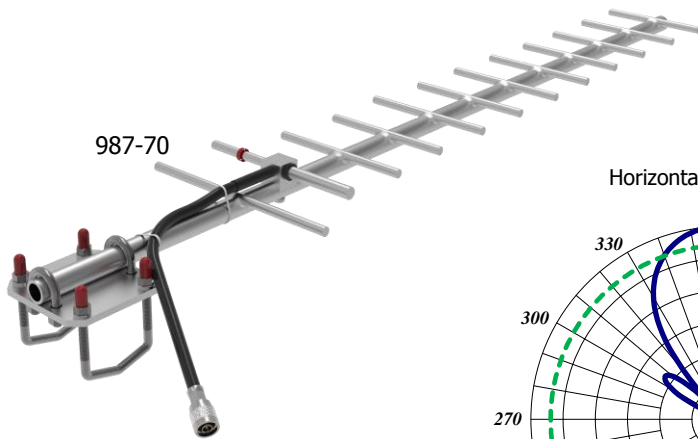
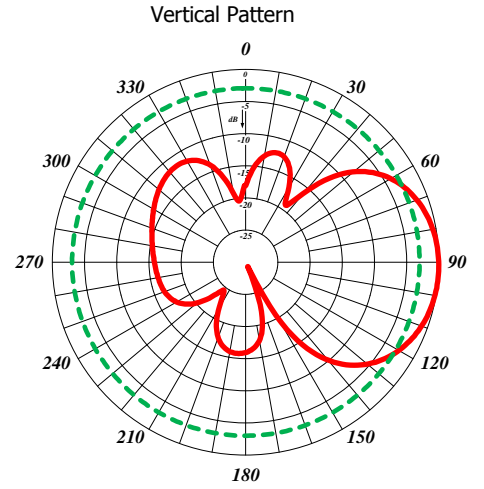
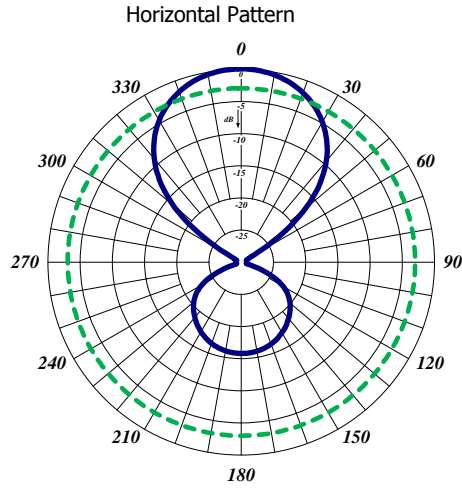

987-70

Horizontal Polarization

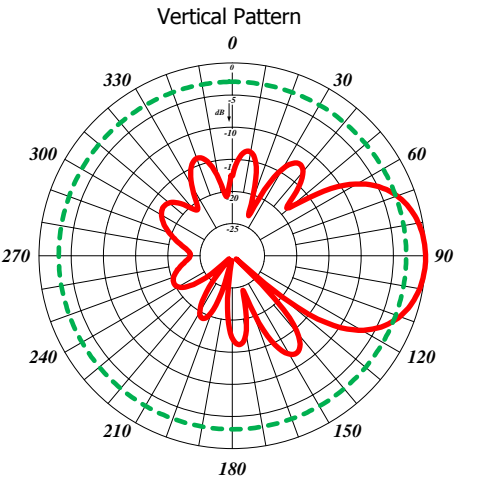
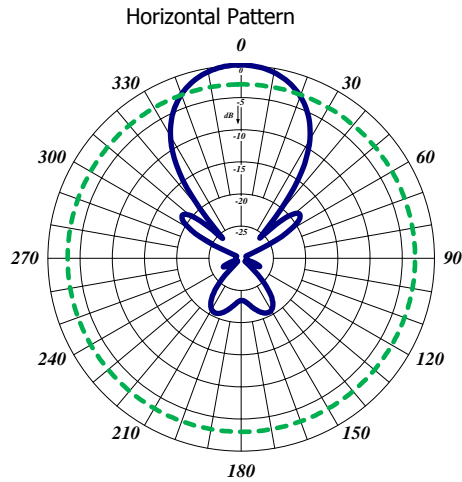

490 Heavy-duty Yagi Antennas Series

The 490 Heavy-duty Yagi Series is an extremely rugged, 7 elements configuration antenna. All our antennas can be completely customized to your particular applications. Our antennas can be black anodized, vertically or horizontally polarized.

- Each antenna has an extremely rugged design to withstand harsh environmental conditions.
- The mounting hardware supplied will permit either vertical or horizontal polarization.
- The 490 Series Yagi antennas are fully welded.
- DC ground for lightning protection.



490-70

Electrical Specifications	490-70
Frequency Range, MHz	806-960
Nominal Gain, dBd	10.0
Number of Elements	7
Bandwidth: 1.5:1 VSWR, MHz	85
Polarization	Vert. or Horiz.
Horizontal Beamwidth (Horizontal Pol.)	56°
Vertical Beamwidth (Horizontal Pol.)	42°
Front to Back, dB	20
Pattern	Directional
Power Rating, Watts	200
Nominal Impedance, Ohms	50
Standard Termination	Type N Male
Mechanical Specifications	490-70
Length, in. (mm)	27 (686)
Width (1/2 Wave Spacing), in. (mm)	8 (203)
Weight, lbs. (kg)	2.5 (1.1)
Rated Wind Velocity, No Ice, mph (km/h)	150 (241)
Rated Wind Velocity, 0.5" (13mm) ice, mph (km/h)	150 (241)
Lateral Thrust @ 100 mph, wind, lbs. (kg)	38 (17)
Bending Moment @ top clamp: 100 mph, ft.*lb (kg*m)	13 (1.8)
Projected Area, ft ² (m ²)	0.4 (0.04)
Mounting Hardware Included	127-85



Horizontal Polarization

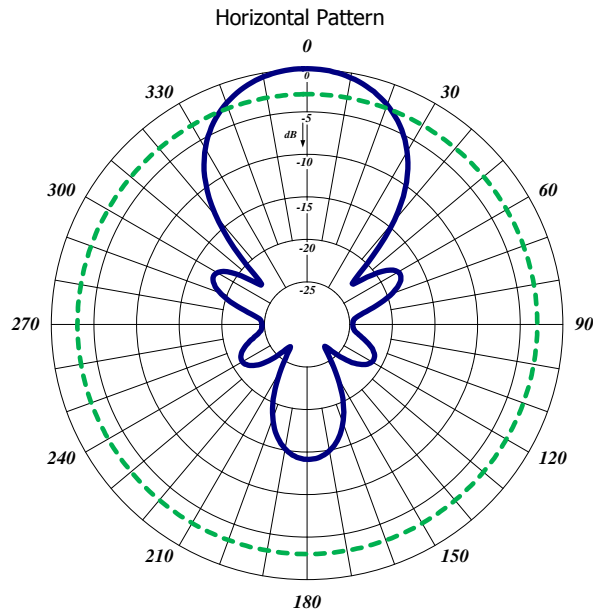

Vertical Pattern

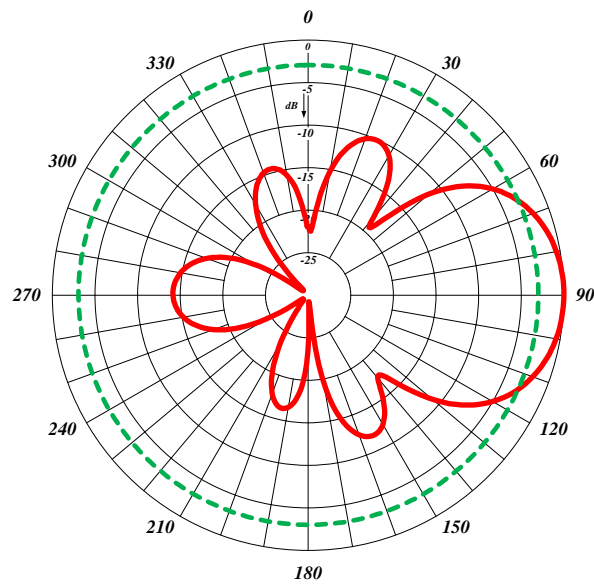

Radome Yagi Antennas Series

The Radome Yagi Antenna Series are available in UHF and 700/800/900 MHz configurations. The UHF model is offered with a Fiberglass or PVC Radome. The 700/800/900 MHz model is offered in PVC. All our antennas can be completely customized to your particular applications.

- Each antenna has a rugged design to withstand extreme environmental conditions.
- The mounting hardware supplied supports either vertical or horizontal polarization.
- DC ground for lightning protection.
- The PVC enclosure is 1/2 inch thick.
- These are our Heavy-Duty Versions. Please contact our Technical Support team for consultation.

Electrical Specifications	425-70	426-70	490-70R
Frequency Range, MHz	406-512	406-512	746-960
Nominal Gain, dBd	10	10	10
Number of Elements	Loop Yagi	Loop Yagi	7
Bandwidth: 1.5:1 VSWR, MHz	20	20	72
Polarization	Vert./Hor.	Vert./Hor.	Vert./Hor.
Horizontal Beamwidth (Horizontal Pol.)	62°	62°	56°
Vertical Beamwidth (Horizontal Pol.)	48°	48°	42°
Front to Back, dB	20	20	20
Pattern	Directional	Directional	Directional
Power Rating, Watts	250	250	150
Nominal Impedance, Ohms	50	50	50
Lightning Protection	DC Ground	DC Ground	DC Ground
Standard Termination	Type N Male	Type N Male	Type N Male
Mechanical Specifications	425-70	426-70	490-70R
Length, in. (mm)	31 (787)	30 (762)	29 (737)
Width (1/2 Wave Spacing), in. (mm)	16 (406)	16 (406)	14 (356)
Weight, lbs. (kg)	44 (20)	19 (8.6)	28 (12)
Radome Material	PVC	Fiberglass	PVC
Rated Wind Velocity, No Ice, mph (km/h)	150 (241)	120 (193)	150 (241)
Rated Wind Velocity, 0.5" (13mm) ice, mph (km/h)	105 (169)	110 (177)	115 (185)
Lateral Thrust @ 100 mph, wind, lbs. (kg)	69 (31.3)	61 (27.7)	47.4 (21.5)
Projected Area, ft ² (m ²)	2.6 (0.24)	2.3 (0.21)	1.8 (0.17)
Mounting Hardware Included	173-85 clamp	173-85 clamp	173-85 clamp



490-70R



425-70

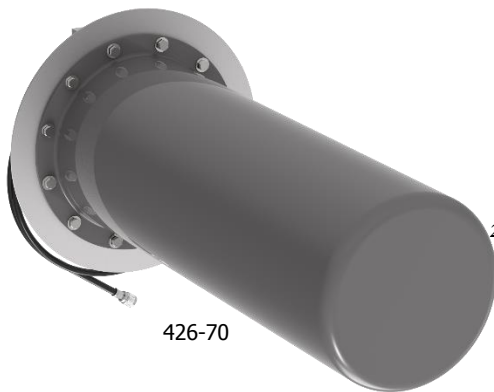
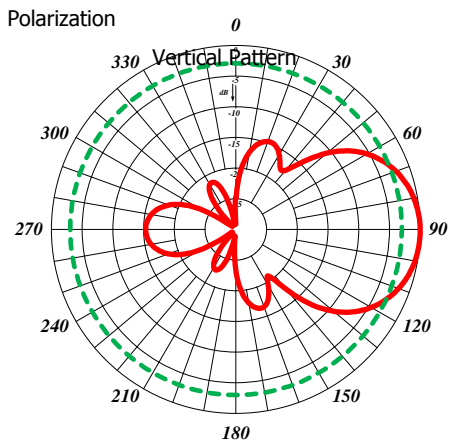
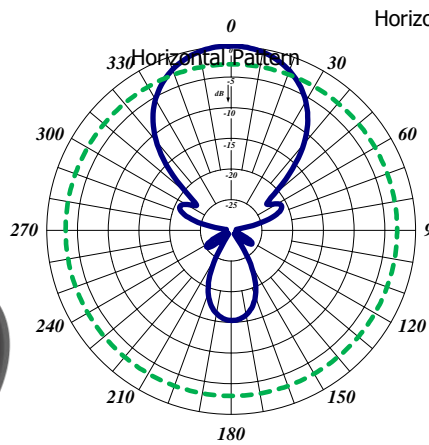

426-70

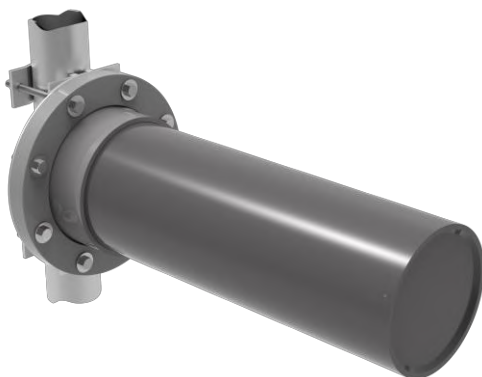
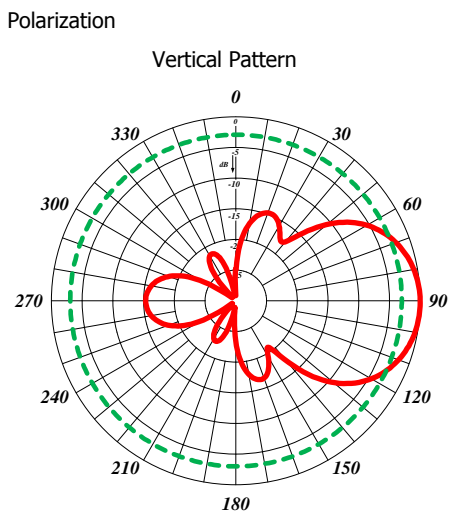
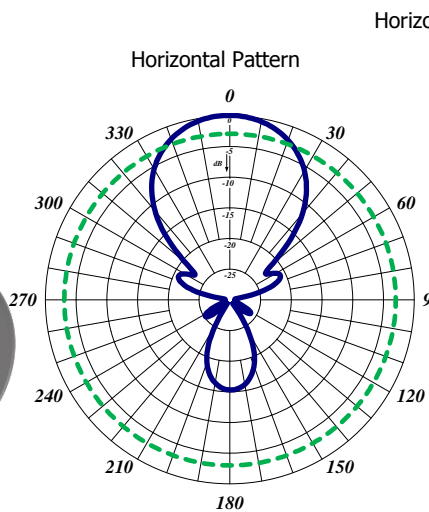

490-70R

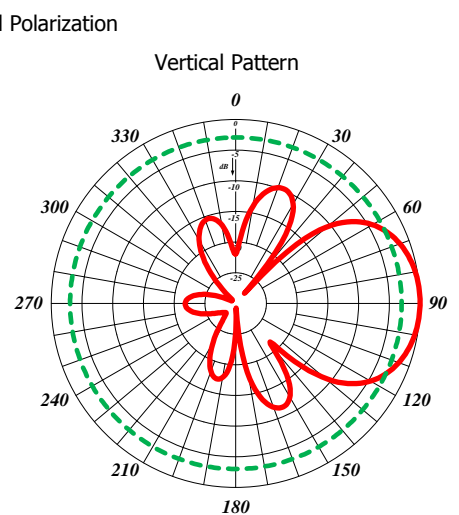
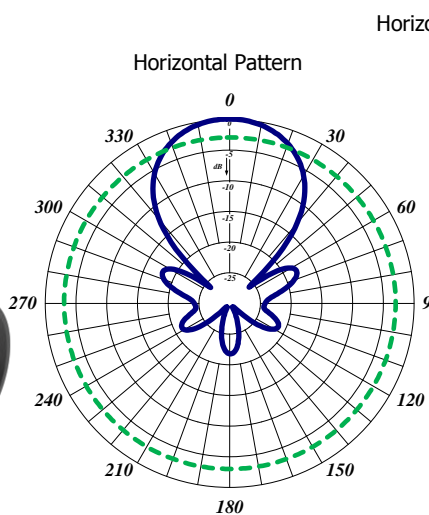

220MHz Corner Reflector Antenna Series

The Corner Reflector Antennas are available in VHF, UHF, 700/800/900 MHz configurations. These antennas have a very high front-to-back ratio. They are broadband and are ideal for point-to-point applications. Performance is constant throughout the band.

- Each antenna has a rugged design to withstand harsh environmental conditions.
- Single or Dual Dipole mounted in the front of a 90° reflector, providing good directivity.
- These antennas have ultra-low VSWR ratings, and will not exceed 2.0:1 VSWR ratio with 0.5" of radial ice.
- The supplied mounting hardware allows either vertical or horizontal polarization. DC ground for lightning protection. Heavy-duty versions are available. Please contact our Technical Support team for consultation.

Electrical Specifications	470-70-2	470-70-2HD	471-70-2
Frequency Range, MHz	215-225	215-225	215-225
Nominal Gain, dBd	7.0	7.0	10.0
Bandwidth: 1.5:1 VSWR, MHz	10	10	10
Polarization	Vert. or Horiz.	Vert. or Horiz.	Vert. or Horiz.
Horizontal Beamwidth (Vert. Pol.)	67°	67°	50°
Vertical Beamwidth (Vert. Pol.)	75°	75°	66°
Front to Back, dB	30	30	30
Pattern	Directional	Directional	Directional
Power Rating, Watts	250	250	250
Nominal Impedance, Ohms	50	50	50
Lightning Protection	DC Ground	DC Ground	DC Ground
Standard Termination	Type N Male	Type N Male	Type N Male
Mechanical Specifications	470-70-2	470-70-2HD	471-70-2
Length, in. (mm)	48 (1219)	48 (1219)	72 (1829)
Width, in. (mm)	75 (1905)	75 (1905)	120 (3048)
Weight, lbs. (kg)	39 (17.7)	57 (25.8)	55 (30)
Rated Wind Velocity, No Ice, mph (km/h)	100 (161)	140 (225)	100 (161)
Rated Wind Velocity, 0.5" (13mm) ice, mph (km/h)	85 (137)	100 (161)	85 (137)
Lateral Thrust @ 100 mph, wind, lbs. (kg)	144 (65)	236 (107)	320 (145)
Projected Area, ft ² (m ²)	5.3 (0.5)	8.8 (0.82)	11.9 (1.10)
Mounting Hardware Included	172-85 Clamp	172-85 Clamp	172-85 Clamp



470-70-2HD

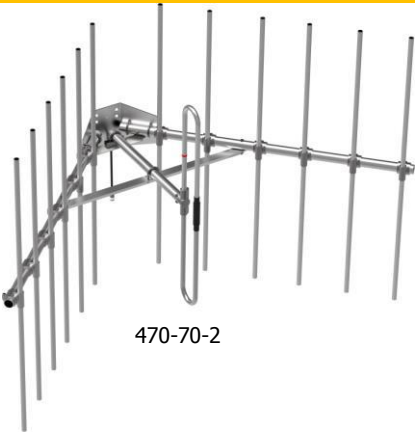

470-70-2

Vertical Polarization

Horizontal Pattern

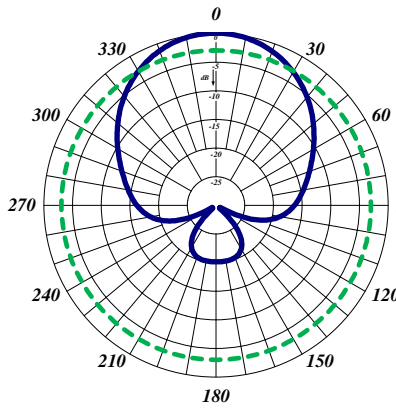

Vertical Pattern

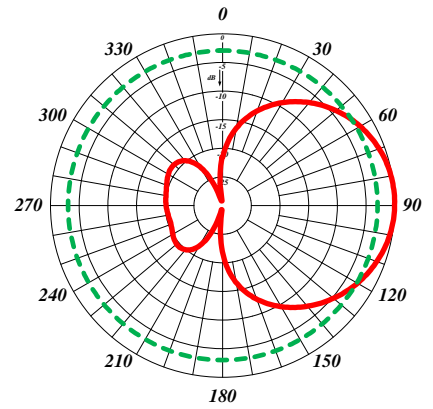

Vertical Polarization

Horizontal Pattern

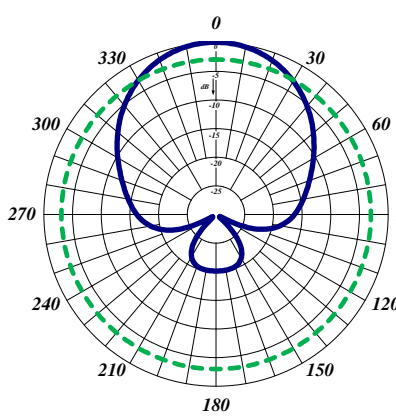

Vertical Pattern

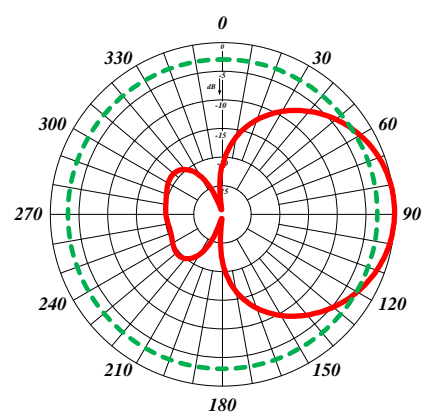

470-70-2HD

Vertical Polarization

Horizontal Pattern

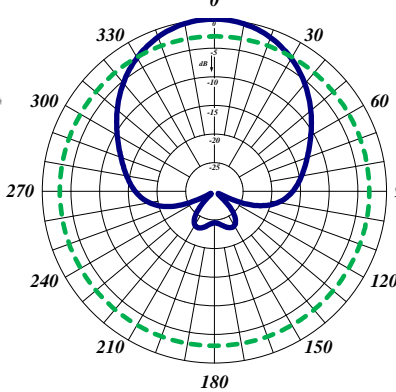

Vertical Pattern

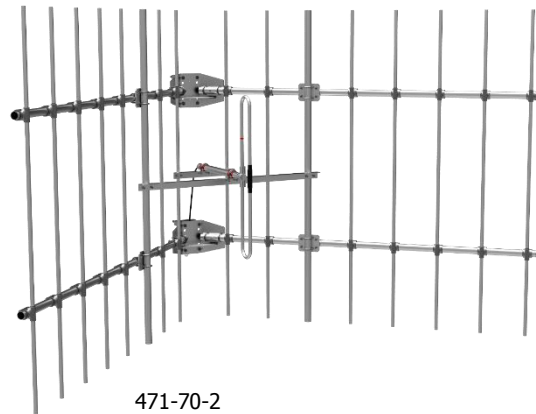
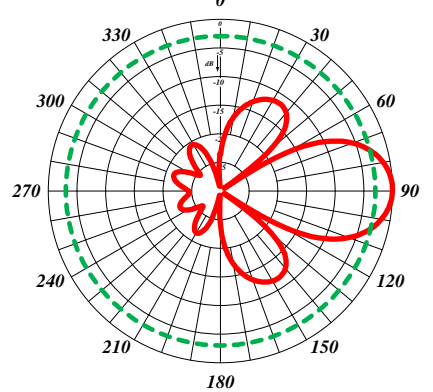

471-70-2

790 Series Enclosed Dipole

The 790 Series Enclosed Dipoles are available in 2, 4 or 8 dipole configurations. All our antennas can be completely customized to your particular applications.

- Each antenna is offered in an offset pattern, 1/4 or 1/2 wave versions.
- Broadband antennas are ideal for trunking or cellular applications.
- Weatherproof radome to ensure continuous service during severe environmental conditions.
- Versions with 3, 6, and 9-degree downtilt are also available.

Electrical Specifications	792-70	794-70	799-70
Frequency Range, MHz	746-960	746-960	746-960
Nominal Gain, dBd	5.0	8.0	10.0
Number of Dipoles	2	4	8
Bandwidth 1.5:1 VSWR, MHz	150	150	150
Polarization	Vertical	Vertical	Vertical
Pattern	Offset	Offset	Offset
Power Rating, Watts	150	300	500
Nominal Impedance, Ohms	50	50	50
Lightning Protection	DC Ground	DC Ground	DC Ground
Standard Termination	Type N Male	Type N Male	Type N Male
Mechanical Specifications	792-70	794-70	799-70
Length, in. (mm)	22 (559)	44.5 (1130)	94 (2388)
Width (1/2 Wave Spacing), in. (mm)	2.5 (64)	2.5 (64)	2.5 (64)
Weight, lbs. (kg)	8.8 (4)	14 (6.5)	24 (11)
Rated Wind Velocity, No Ice, mph (km/h)	100 (162)	100 (162)	100 (162)
Rated Wind Velocity, 0.5" (13mm) ice, mph (km/h)	85 (137)	85 (137)	85 (137)
Lateral Thrust @ 100 mph, wind, lbs. (kg)	36.4 (16.5)	73 (33)	153 (59)
Projected Area, ft ² (m ²)	1.4 (0.13)	2.7 (0.25)	5.7 (0.53)
Mounting Information	1.5-2.88" O.D.	1.5-2.88" O.D.	1.5-2.88" O.D.





792-70

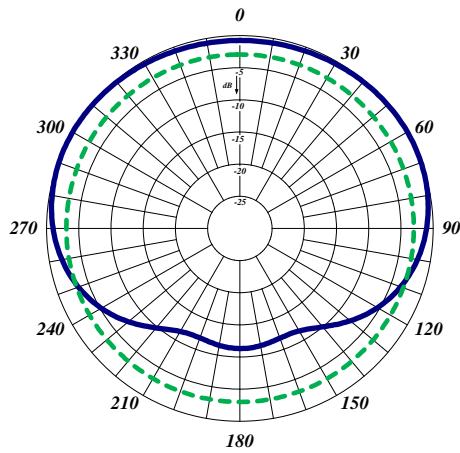

Half-wave Spacing Horizontal

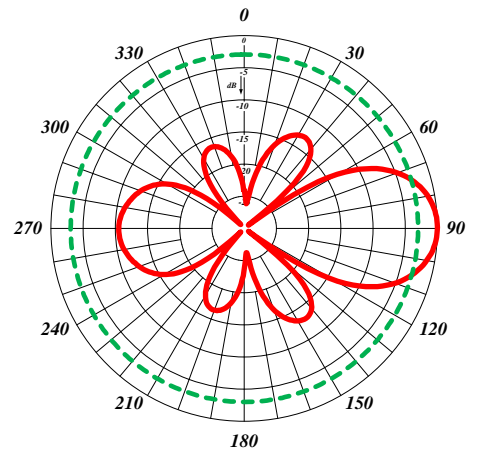

Half-wave Spacing Vertical



794-70

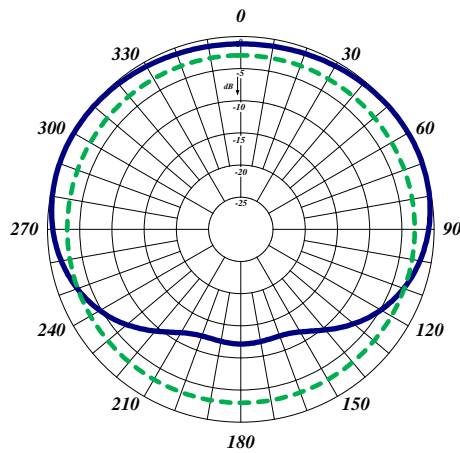

Half-wave Spacing Horizontal

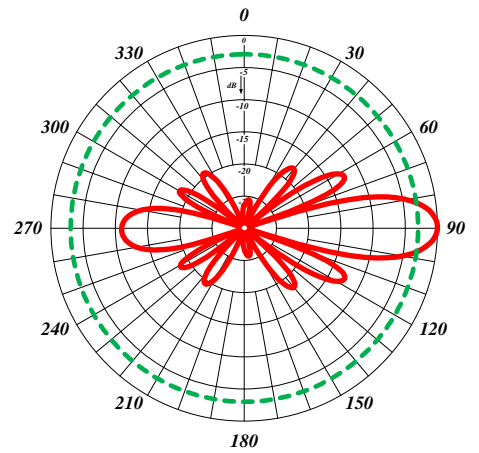

Half-wave Spacing Vertical



799-70

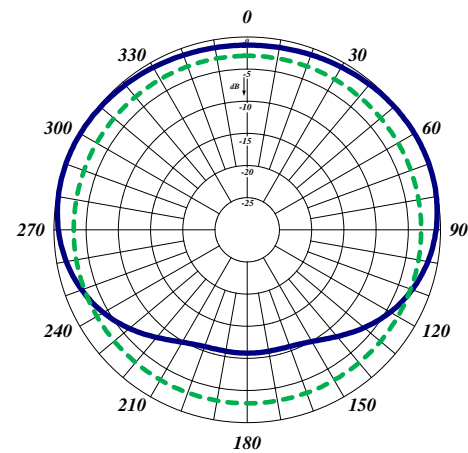

Half-wave Spacing Horizontal

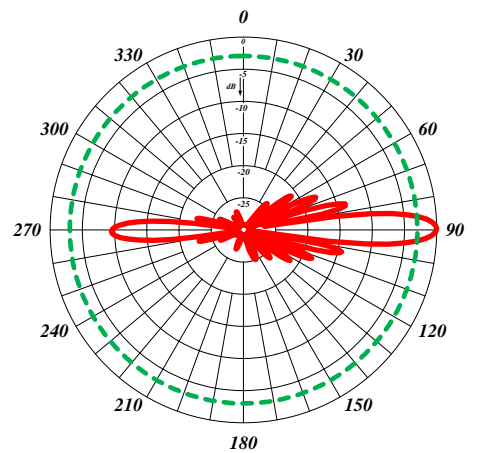

Half-wave Spacing Vertical

357-75, 358-75 and 364-75

Our line of VHF transit antennas is a low profile rugged alternative to a 1/4 wave whip mobile antenna. When mounted on a horizontal surface, maximum radiation is omnidirectional and vertically polarized.

These antennas are an excellent choice for low clearance applications such as those found on trains, public transit vehicles, construction equipment and police vehicles.

The model 357-75-ABS is a folded 1/4 wavelength section of aluminum tube housed in an impact resistant ABS radome. To ensure a moisture proof installation, the model 357-75-ABS is supplied with a mounting gasket.

The model 358-75 and 364-75 are high strength cast aluminum designs. The antennas can be coated for additional protection against harsh environmental conditions. To ensure a moisture proof installation, the 358-75 and 364-75 are supplied with an O-ring.

Electrical Specifications	357-75-ABS	358-75	364-75
Nominal Gain	Unity	Unity	Unity
Maximum Power, Watts	150	150	150
Frequency Range, MHz	148-174	138-174	215-225
Bandwidth VSWR: 1.5:1, MHz	3.0	3.0	10
Bandwidth VSWR: 2.0:1, MHz	4.5	4.5	>10
Nominal Impedance, Ohms	50	50	50
Radiation Pattern	Omni	Omni	Omni
Polarization	Vertical	Vertical	Vertical
Radome Material	High Impact ABS	N/A	N/A
Connector	UHF / BNC / N Female	UHF / BNC / N Female	UHF / BNC / N Female
Height, in. (mm)	4 (102)	4 (102)	4 (102)
Length, in. (mm)	21 (533)	23-1/2 (597)	17 (432)
Width, in. (mm)	3 (76)	2-1/8 (54)	2 (51)
Weight, lbs (kg)	2.1 (0.945)	6 (2.7)	5 (2.27)
Minimum Ground Plane Size, in. (mm)	36 x 48 (914 x 1219)	36 x 48 (914 x 1219)	36 x 48 (914 x 1219)

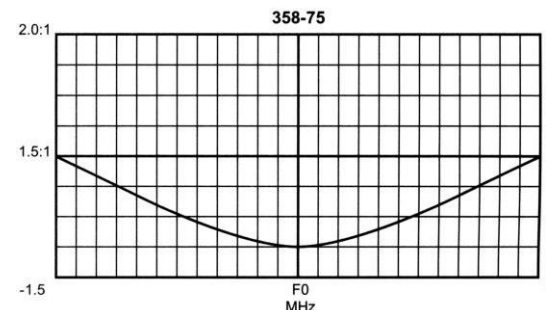
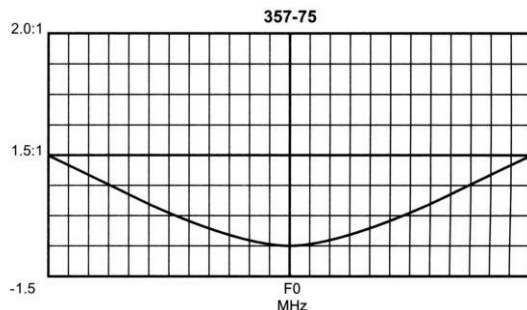
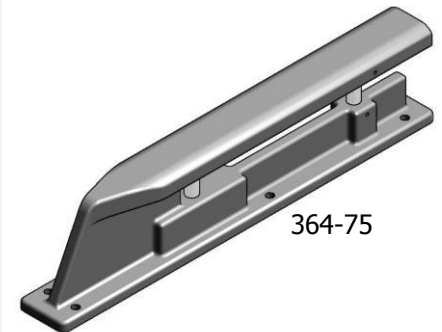
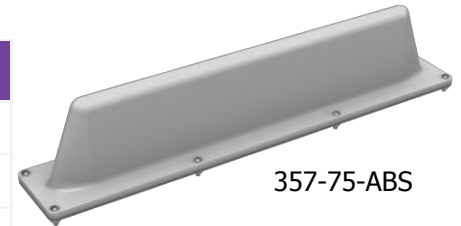

359-75 and 360-75

Our line of UHF transit antennas is a low profile rugged alternative to 1/4 wave whips. When mounted on a horizontal surface, maximum radiation is omnidirectional and vertically polarized.

These antennas are an excellent choice for low clearance applications such as those found on trains, public transit vehicles, construction equipment and police vehicles.

The model 359-75 is a high strength cast aluminum design. The antenna can be coated for additional protection against harsh environmental conditions. To ensure a moisture proof installation, the model 359-75 is supplied with an O-ring.

The model 360-75-ABS is a folded 1/4 wavelength section of aluminum tube housed in an impact resistant ABS radome. To ensure a moisture proof installation, the model 360-75-ABS is supplied with a mounting gasket.

Electrical Specifications	359-75	360-75-ABS
Nominal Gain	Unity	Unity
Maximum Power, Watts	125	125
Frequency Range, MHz	406-512	406-512
Bandwidth VSWR: 1.5:1, MHz	18	20
Bandwidth VSWR: 2.0:1, MHz	27	40
Nominal Impedance, Ohms	50	50
Radiation Pattern	Omnidirectional	Omnidirectional
Polarization	Vertical	Vertical
Radome Material	N/A	High Impact ABS
Connector	UHF / BNC / N Female	UHF / BNC / N Female
Height, in. (mm)	2-1/2 (64)	3 (76)
Length, in. (mm)	8 (203)	11 (279)
Width, in. (mm)	2 (51)	3-1/4 (83)
Weight, lbs (kg)	0.75 (0.338)	1 (0.45)
Minimum Ground Plane Size, in. (mm)	20 x 16 (508 x 406)	20 x 16 (508 x 406)

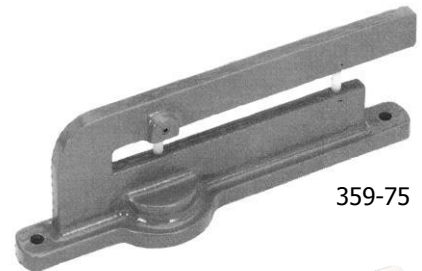

359-75



360-75-ABS

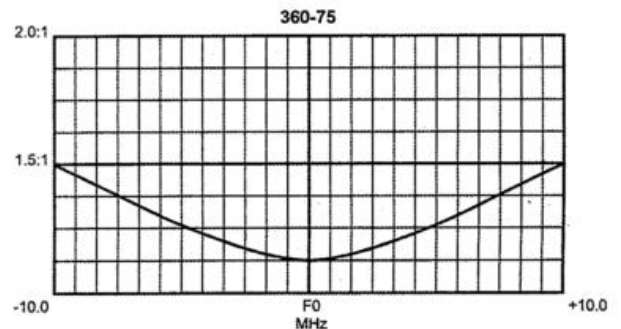
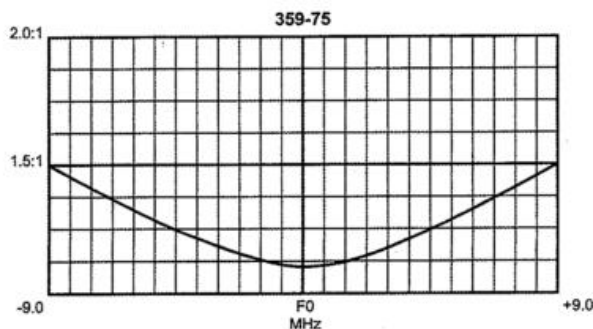

361-75 and 362-75

Our line of radome transit antennas for operation in the 806-960 MHz band consists of compact, low profile antennas in weatherproof ABS radomes. When mounted on a horizontal surface, maximum radiation is omnidirectional and vertically polarized.

These antennas are an excellent choice for low clearance applications such as those found on trains, mass transit vehicles, construction equipment and police and emergency vehicles.

The 361-75-ABS model is a space diversity design that provides greater communication reliability in a poor environment. To ensure a moisture proof installation, the 361-75-ABS model is supplied with an O-ring.

The 362-75-ABS model is a standard, folded radiator housed in a sturdy high-impact ABS radome. To ensure a moisture proof installation, the 362-75-ABS model is supplied with a mounting gasket.

Electrical Specifications	361-75-ABS	362-75-ABS
Nominal Gain	Unity	Unity
Maximum Power, Watts	50	125
Frequency Range, MHz	806-960	806-960
Bandwidth VSWR: 1.5:1, MHz	140	66
Bandwidth VSWR: 2.0:1, MHz	N/A	100
Nominal Impedance, Ohms	50	50
Radiation Pattern	Omnidirectional	Omnidirectional
Polarization	Vertical	Vertical
Radome Material	High Impact ABS	High Impact ABS
Connector	N Female	N Female
Height, in. (mm)	3.15 (80)	2 (51)
Diameter, in. (mm)	9.3 (236)	4.5 (114)
Weight, lbs (kg)	2.5 (1.15)	0.375 (0.169)
Minimum Ground Plane Size, in. (mm)	14 x 14 (355 x 355)	10 x 10 (254 x 254)



361-75-ABS

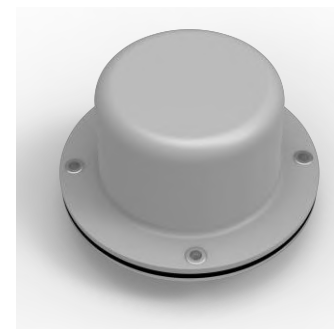

362-75-ABS

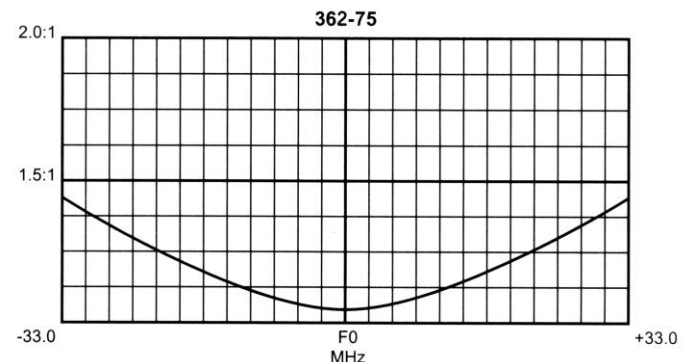
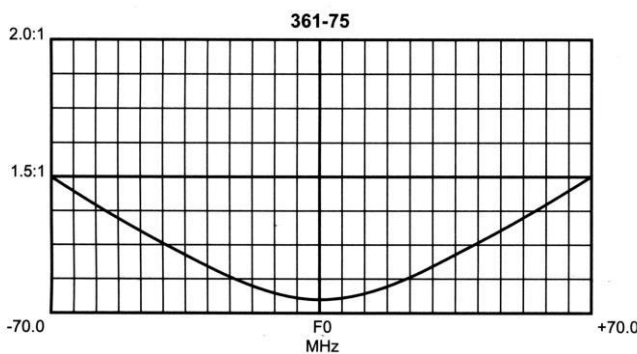

66-FF-2P Series 2" Cavity Duplexers

Our 2" base station duplexers are ideal for compact high isolation installations. These filters are designed for the combination of two frequencies that require extra isolation or they can be used as efficient preselectors. Available in either 4 or 6 cavity configurations if higher levels of isolation are required. Selectivity can be determined by the field adjustable capacitors. Each cavity is temperature compensated for operation between -40°C to +60 °C. Each cavity has a gold Alodine finish, silver-plated loops, and silver-plated tuning rods.

- Temperature Compensation
 - Ensures Frequency Stability
- High Attenuation
 - Minimizes desense and interference from adjacent systems



Electrical Specifications	66-13-24	66-14-24	66-13-26	66-14-26
Frequency Range, MHz	132-150	144-174	132-150	144-174
Frequency Spacing Min.	4.5	4.5	3.0	3.0
Cavity Number	4	4	6	6
Cavity Diameter, in.	2.0	2.0	2.0	2.0
Continuous Power Inputs, Watts	100	100	100	100
Connectors (Equipment/Antenna)	BNC/N	BNC/N	BNC/N	BNC/N
Insertion Loss, dB (maximum)	1.5	1.5	1.5	1.5
Channel Isolation, dB	70	70	80/90	80/90
VSWR	1.3:1		1.3:1	
Temperature °C	-40 to +60	-40 to +60	-40 to +60	-40 to +60
Mechanical Specifications	66-13-24	66-14-24	66-13-26	66-14-26
Maximum length, in. (H x W x D)	5.25 x 19 x 7.25		5.25 x 19 x 7.25	
Mounting	19" Rack Mount			

These duplexers are available in other frequencies and configurations. Please call our technical support for additional models.



3" Cavity Band Pass Duplexer VHF/220MHz

This band pass duplexer is to be used with our single feed line of dual band antennas. Our 3" base station duplexers are ideal for compact high isolation installations. These filters are designed for the combination of two frequencies that require extra isolation or they can be used as efficient pre-selectors. Each cavity is temperature compensated for operation between -40°C to +60°C. Each cavity has a gold alodine finish, silver plated loops and silver plated tuning rods.



Electrical Specifications

Frequency Range, MHz	144-222
Frequency Spacing Min., MHz	8
Number of Cavities, Diameter, in.	(7) – 3" Square
Continuous Power Input, Watts	125
Connectors	N Female
Insertion Loss, dB	2.2
Channel Isolation @ Min. Sep., dB	90
VSWR	1.5:1
Temperature Range, °C	-40 to +60

Mechanical Specifications

Mounting	19" Rack
Dimensions (W x H x D), in.	19 x 7 x 7
Weight, lbs.	15

Antenna to 160-162 MHz Port

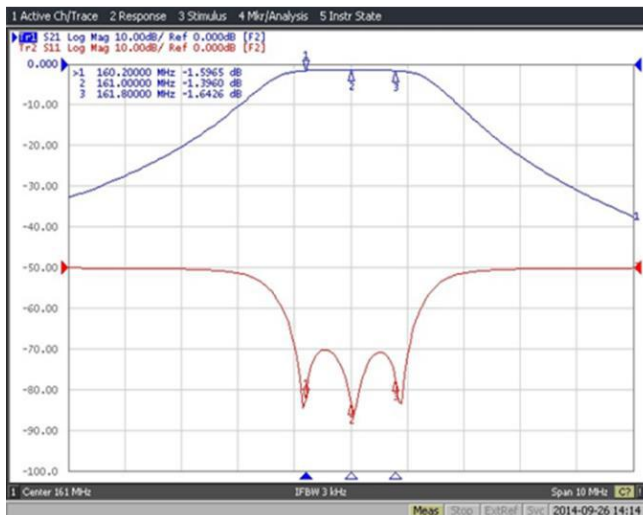

Antenna to 220-222 MHz Port



2" Cavity Filters

Our 2" filters are ideal for compact high isolation installations. These filters are designed for the isolation of two frequencies or they can be used as efficient pre-selectors. Available in either 4 or 6 cavity configurations if higher levels of isolation are required. Each cavity is temperature compensated for operation between -40°C to +60 °C. They have a gold alodine finish, silver plated loops, and silver plated tuning rods.

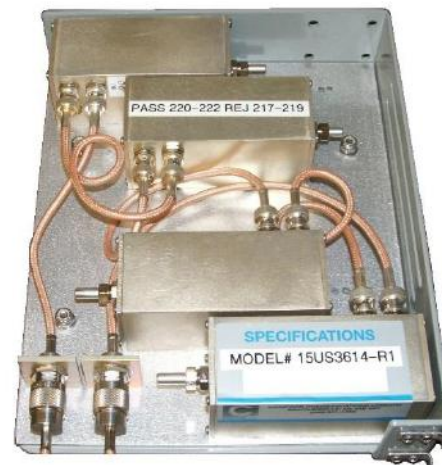

4 Cavity Version Shown

Electrical Specifications	
Frequency Range, MHz	215-222
Frequency Spacing Min., MHz	1
Number of Cavities, Diameter, in.	(6) – 2" Square
Continuous Power Input, Watts	100
Connectors	N Female
Insertion Loss, dB	3.2
Channel Isolation @ Min. Sep., dB	50
VSWR	1.22:1
Temperature Range, °C	-40 to +60

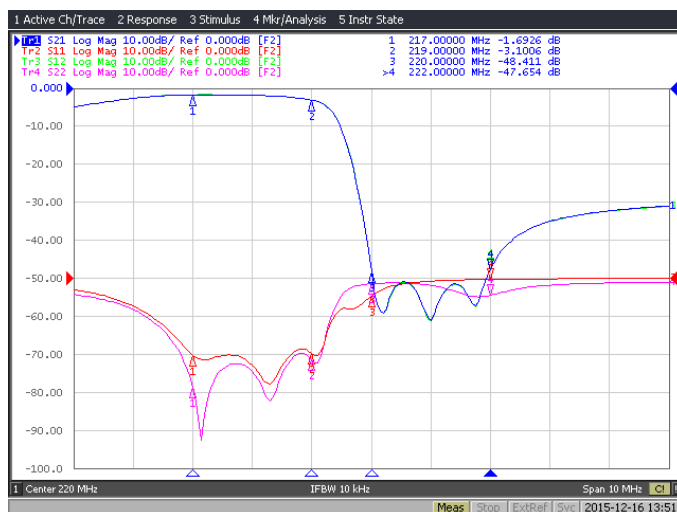
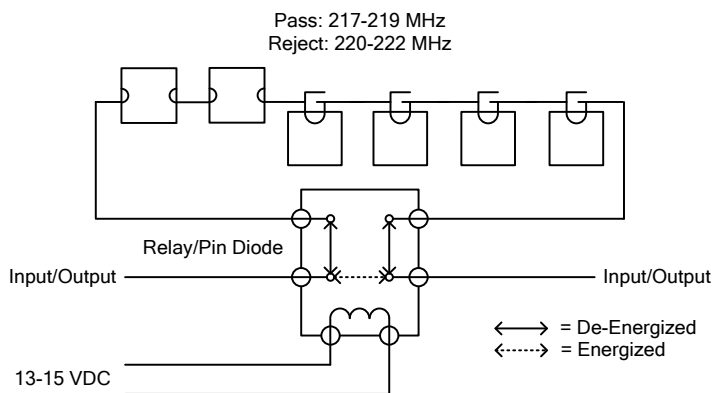

F-33370

The F-33370 Filter is designed to pass frequencies between 216 and 222 MHz while at the same time, rejecting VHF frequencies that are below 160 MHz. With an insertion loss of less than 1 dB, this filter will reject VHF frequencies at -60 dB or more.

- Small physical size
- Excellent performance, low VSWR, low insertion loss
- High power handling
- Maintenance free

**Electrical Specifications**

Frequency Range, MHz	216-222
Insertion Loss, dB	= < 1
Return Loss, dB	= > 20
Reject, dB	= > 60 @ 160 MHz
Power, Watts	100
Connectors (Both Ends)	N Female
Temperature Range, °C	-30 to +60

Mechanical Specifications

Length, in.	7.4
Width, in.	2.2
Height, in.	1.2
Mounting Hole Size, in.	0.15

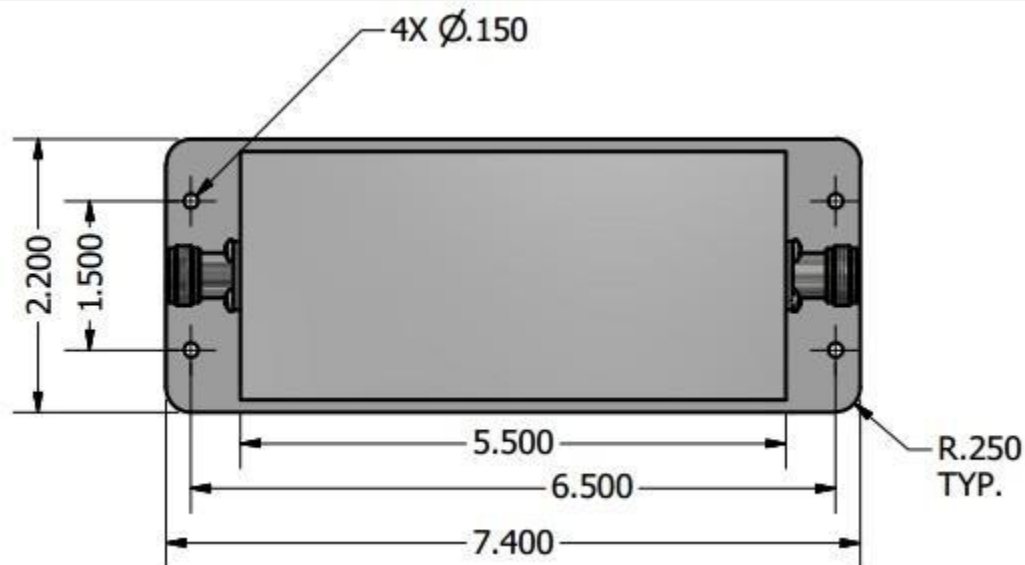

66-FF-44 Series (4) 4" Cavity Duplexers

These 4" base station duplexers are ideal for high power, close frequency separation installations. These filters are designed for combining two frequencies or they can be used as efficient pre-selectors. If higher levels of isolation are required, please consider using 6 cavity configurations. Selectivity can be determined by the field adjustable capacitors. Each cavity is temperature compensated for operation between -40°C to +60°C. Each cavity has a gold Alodine finish, silver-plated loops, and silver-plated tuning rods.

- Temperature Compensation
 - Ensures Frequency Stability
- High Attenuation
 - Minimizes desense and interference from adjacent systems

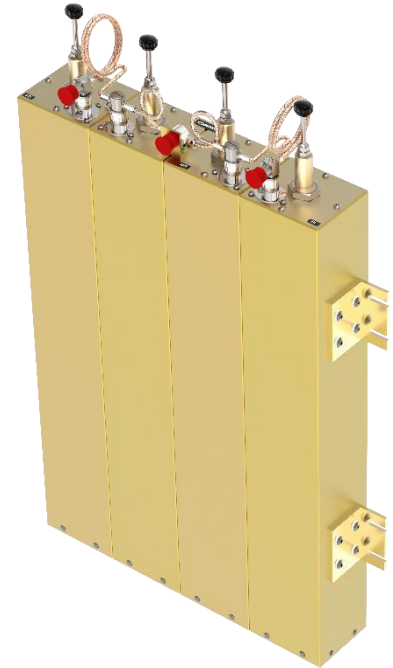

Electrical Specifications	66-13-44	66-40-44	66-80-44
Frequency Range, MHz	138-174	406-512	746-960
Frequency Spacing Min. MHz	0.5	0.3	1.5
Cavities, Diameter, in.	(4) - 4" Square	(4) - 4" Square	(4) - 4" Square
Continuous Power Input, Watts	350	350	350
Connectors	N Female	N Female	N Female
Insertion Loss, dB (maximum)	1.5	0.8	0.8
Channel Isolation, dB	70	75	90
VSWR	1.2:1	1.2:1	1.2:1
Temperature °C	-40 to +60	-40 to +60	-40 to +60
Mechanical Specifications	66-13-44	66-40-44	66-80-44
Maximum length, in. (H x W x D)	31 x 19 x 4	4 x 19 x 15	4 x 19 x 12
Weight, lbs (kg)	30 (13.6)	18 (8.2)	16 (7.3)
Mounting	19" Rack Mount		

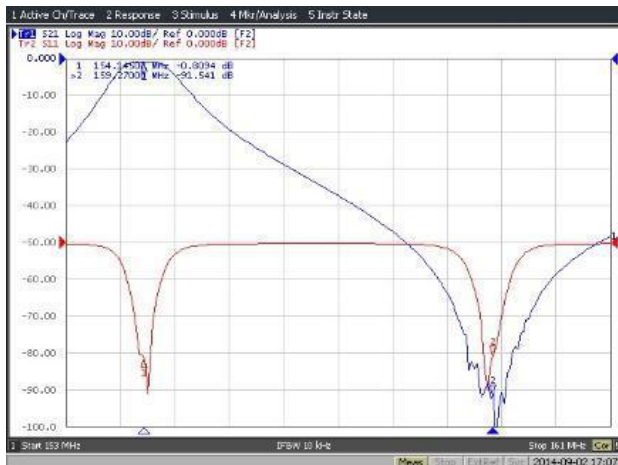

66-13-44

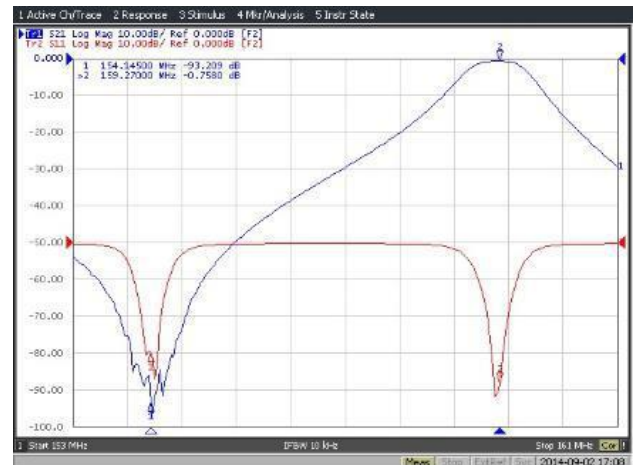

66-FF-46 Series (6) 4" Cavity Duplexers

These 6-cavity 4" base station duplexers are ideal for high power close frequency separation installations. These filters are designed for the combination of 2 frequencies that require extra isolation or they can be used as an efficient pre-selector. If higher levels of isolation are required, please consider using the 8-cavity configuration. Selectivity can be determined by the field adjustable loops. Each cavity is temperature compensated for operation between -40°C to +60°C. Each cavity has a gold Alodine finish, silver-plated loops, and silver-plated tuning rods.

- Temperature Compensation
 - Ensures Frequency Stability
- High Attenuation
 - Minimizes desense and interference from adjacent systems



Electrical Specifications	66-13-46	66-40-46	66-80-46
Frequency Range, MHz	138-174	406-512	746-960
Frequency Spacing Min. MHz	0.5	3.0	3.6
Cavities, Diameter, in.	(6) - 4" Square	(6) - 4" Square	(6) - 4" Square
Continuous Power Input, Watts	350	350	350
Connectors	N Female	N Female	N Female
Insertion Loss, dB (maximum)	2.1	1.2	1.2
Channel Isolation, dB	85	100	85
VSWR	1.2:1	1.2:1	1.2:1
Temperature °C	-40 to +60	-40 to +60	-40 to +60
Mechanical Specifications	66-13-46	66-40-46	66-80-46
Maximum length, in. (H x W x D)	31 x 19 x 8	8 x 19 x 15	8 x 19 x 12
Weight, lbs (kg)	45 (20.25)	27 (12.15)	24 (10.8)
Mounting	19" Rack Mount		

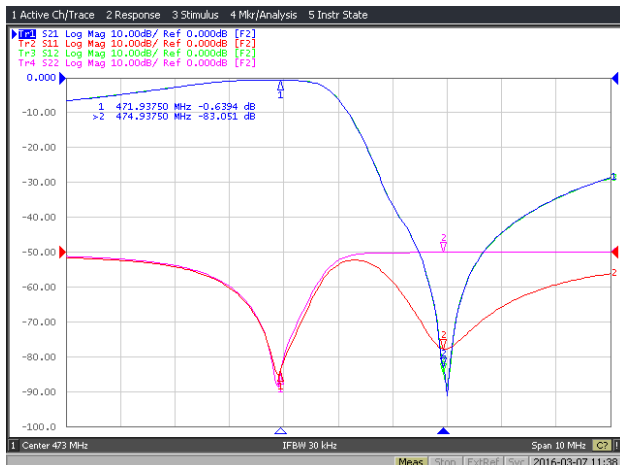

66-40-46

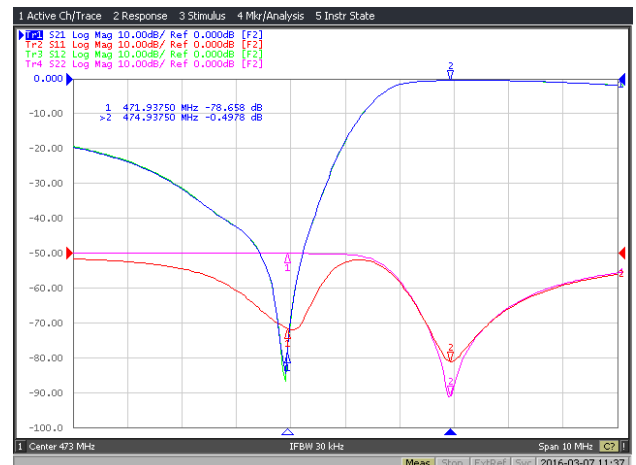



Our Mission:

As a market leader in RF technology, we are committed to delivering best in-class products and services to Public Safety, Utility, Transportation, Defense and Government organizations around the world.



www.comprodcom.com

Toll Free: 1.877.825.2007 USA / 1.800.603.1454 Canada

Fax: 1.800.554.1033 / email: sales@comprodcom.com

USA HEAD OFFICE

3405 N. Benzing Rd.
Orchard Park, NY 14127

CANADA HEAD OFFICE

88 Industrial Blvd.
Boucherville, QC, J4B 2X2

REGIONAL SALES OFFICE

205-259 Midpark Way S.E.
Calgary, AB, T2X 1M2



47 **Tel: US 1.877.825.2007 / CAN 1.800.603.1454**

www.comprodcom.com

Email: sales@comprodcom.com

Fax: 1.800.554.1033